

office system

-eM

O-eM

K-eM

F-eM

Q-eM

A-eM

Lano - C

Lano - T

Lano - E

Beta

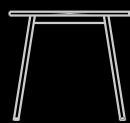
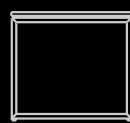
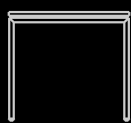
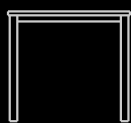

Q-eM



04
maro



05
maro



bench

06
maro



07
maro



Work & shared area

bench



08
maro

09
maro

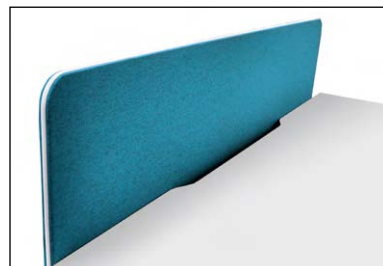
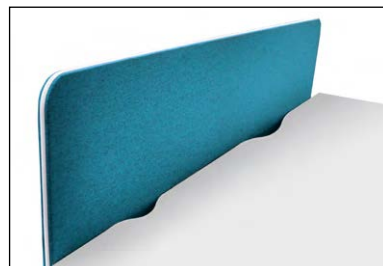
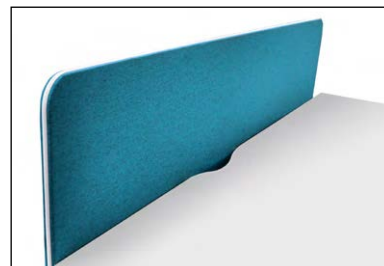

more info maro.pl



F-eM

A-eM



10
maro

11
maro

F-eM

your place of work

12
maro

13
maro



more info maro.pl



K-eM



14
maro



15
maro



740-820



650-850

more info maro.pl

800/1000/1200/1400
1600/1800/2000



1600/1800/2000



1600/1800



1600/1800/2000



1600/1800/2000



1600/1800/2000



420/600/800

420/600

600/800

locker

A-eM, privacy screen

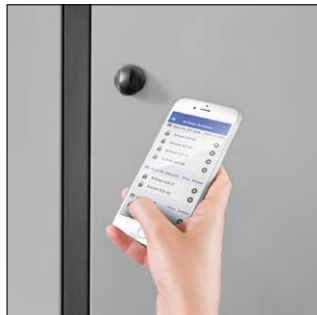

17
maro

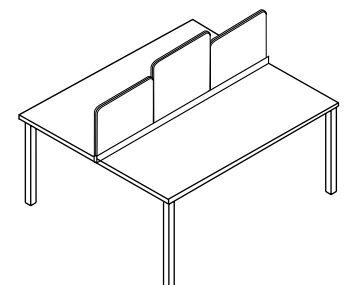
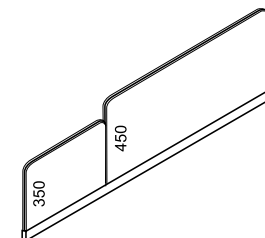
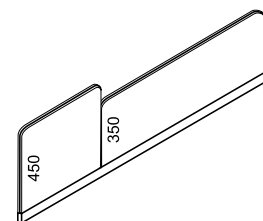
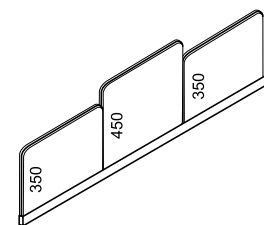
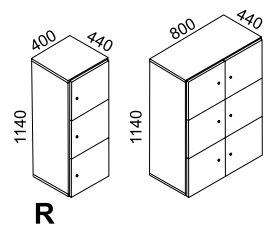
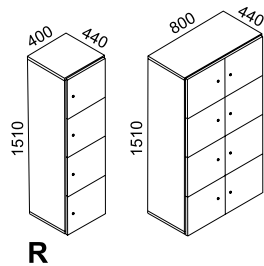
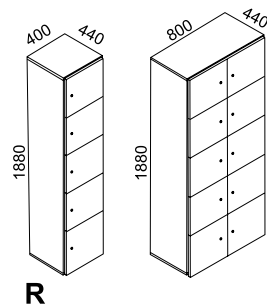

F-eM

18
maro

19
maro



O-eM



20
maro



21
maro

dynamic communication



more info maro.pl





22
maro



23
maro

Accessories-eM

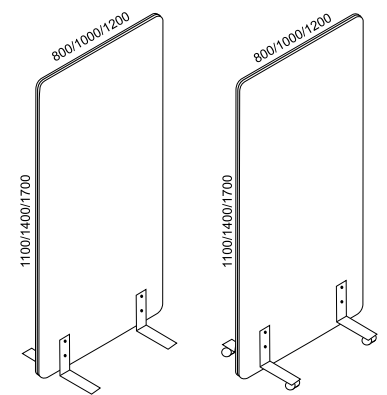

Screens



24
marzo

25
marzo

Lano-T

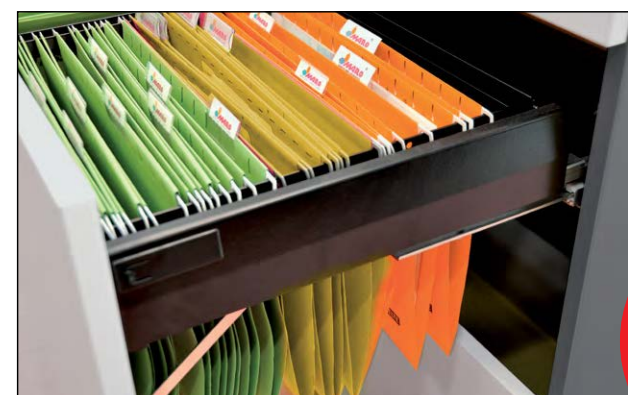

Lano-T

26
marzo

27
marzo



Lano-E

28
maro



29
maro



Panel sterujące/ Control panel/ Höhensteuerung

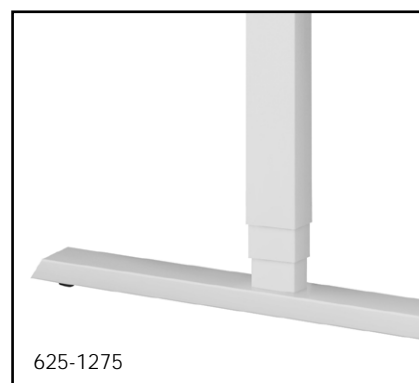

625-1275

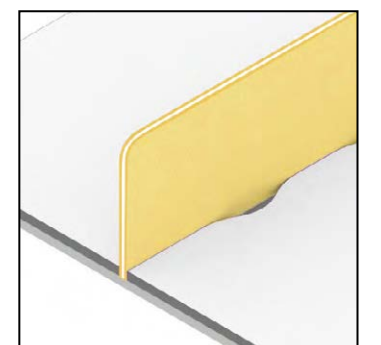
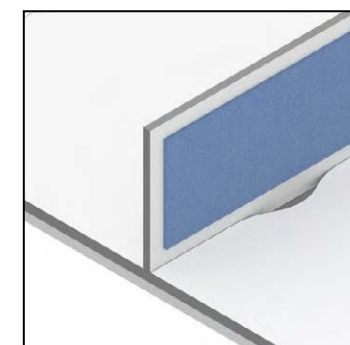

Lano-C

Screen S30

600 / 800 / 1000 / 1200 / 1400 / 1600

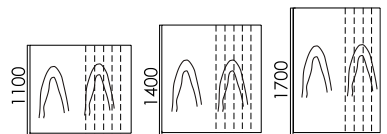
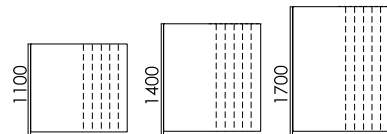

600 / 800 / 1000 / 1200 / 1400 / 1600

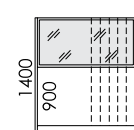

600 / 800 / 1000 / 1200

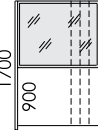

30
maro

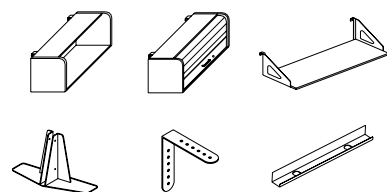

31
maro



Beta

32
maro

33
maro

your style

more info maro.pl



O-eM

K-eM

F-eM

Q-eM

A-eM

Lano - C

Lano - T

Lano - E

Beta

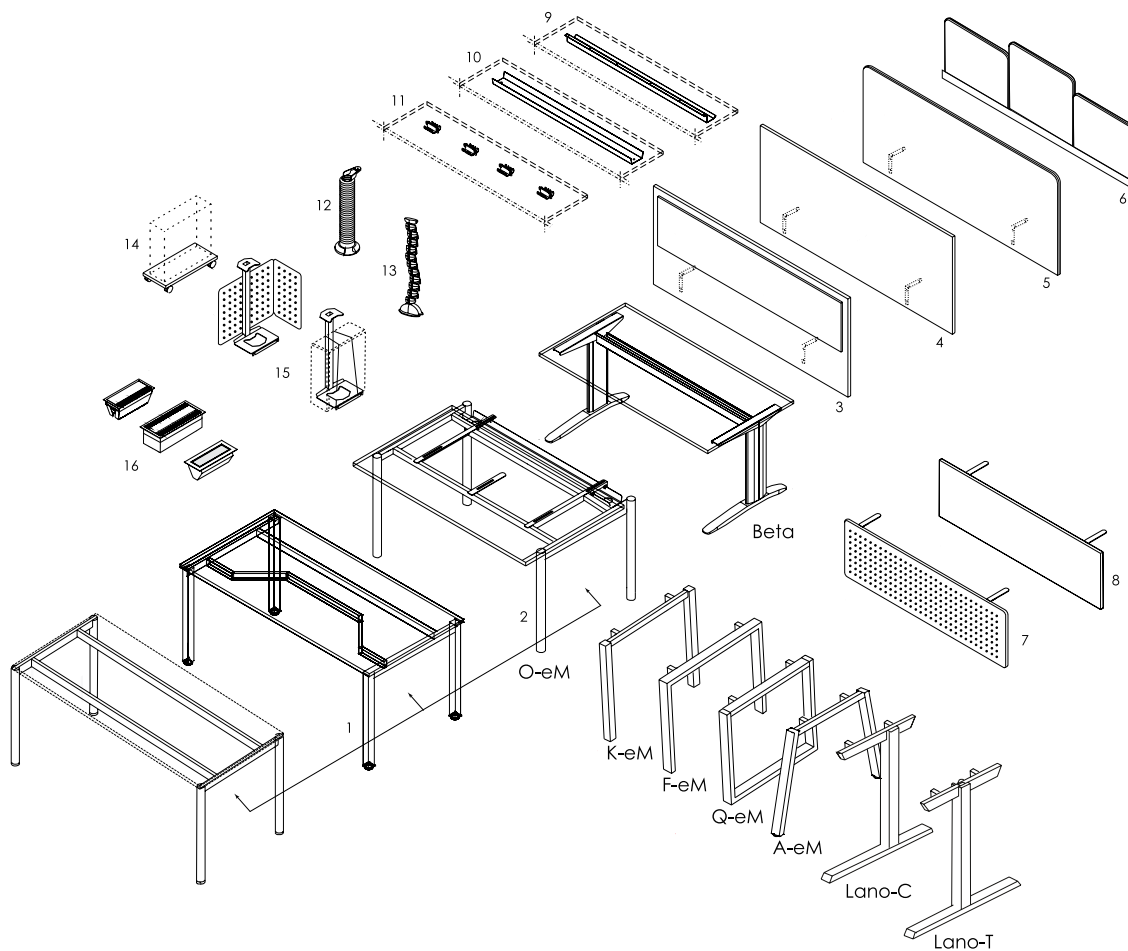
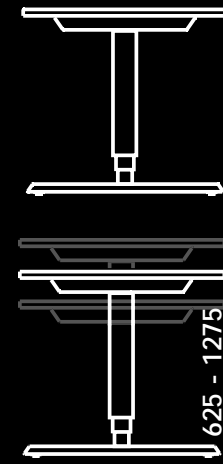
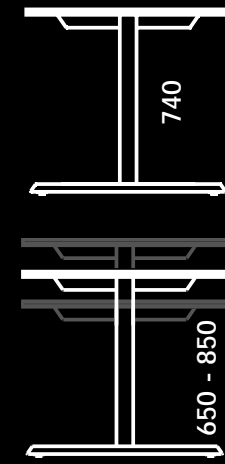
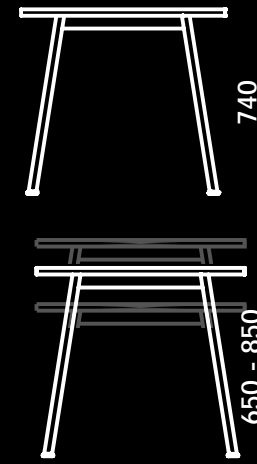
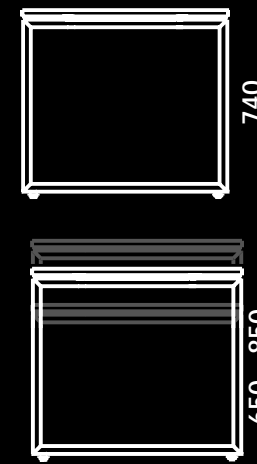
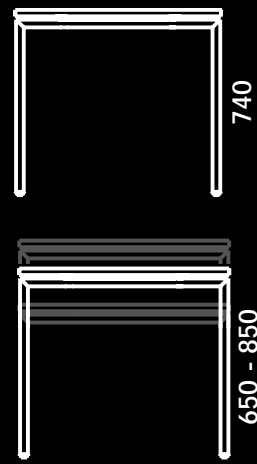
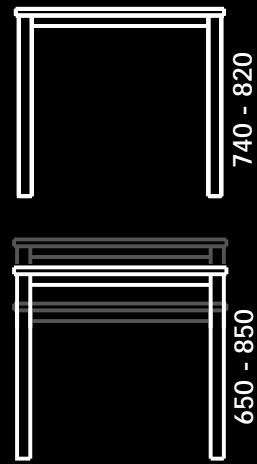
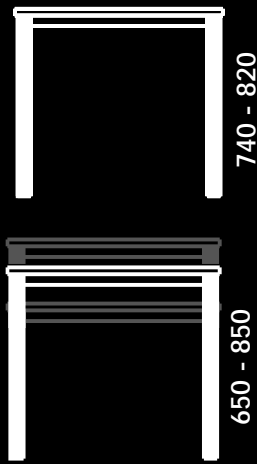

1. Stelaż ergonomiczny/ Ergonomic desk frame/ Ergonomisches Schreibtischgestell

2. Blat przesuwny/ Sliding top/ Schiebeplatte

3. Przegroda podwieszana z pinpanelem/ Privacy screen with fabric pinboard/ Frontsichtblende mit Pinpaneel

4. Przegroda podwieszana/ Basic privacy screen/ Standard Frontsichtblende

5. Przegroda tapicerowana/ Upholstered privacy screen/ Frontsichtblende mit Stoffbezug

6. Przegroda dzielona / Multi privacy screens / Multi Frontsichtblenden

7. Zabudowa rastrowa/ Perforated modesty panel/ Knieblende - Lochblech

8. Zabudowa płytowa/ Melamine modesty panel/ Knieblende - Melamin

9. Kanał kablowy poziomy stały/ Fold-down horizontal cable channel/ Klappbarer Kabelkanal

10. Kanał kablowy poziomy uchylny/ Fixed horizontal cable channel/ Fester Kabelkanal

11. Uchwyty kablowe/ Cable clamps/ Kabelklemmer

12. Elastyczny kanał kablowy/ Flexible cable spine/ Flexibler Kabelkanal

13. Kanał kablowy - sprężyna / Cable channel - spring / Kabelkette vertikal

14. Mobilna podstawa pod komputer/ PC- trolley/ PC- Wagen

15. Wsporniki pod komputer/ PC- holder/ PC- Halter

16. Mediaporty / Netbox/ Strom-Daten-Box

Biurka/ Desks/ Schreibtische

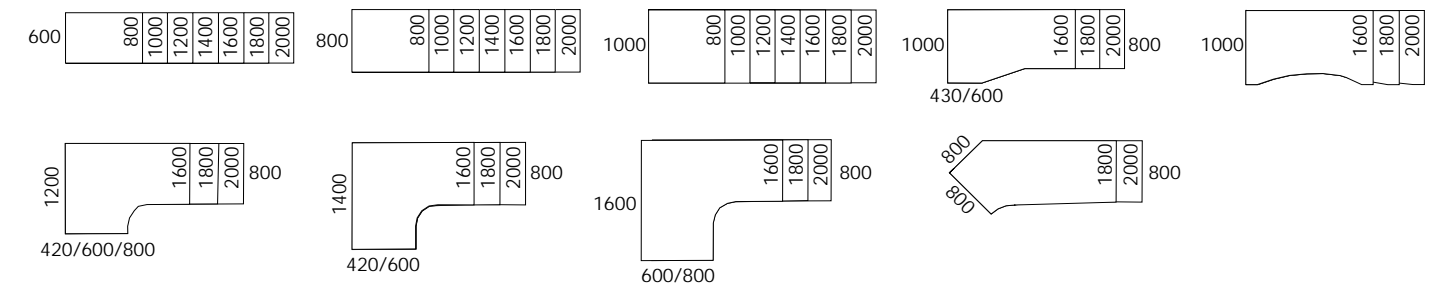

Stoły konferencyjne/ Conference tables/ Konferenztische

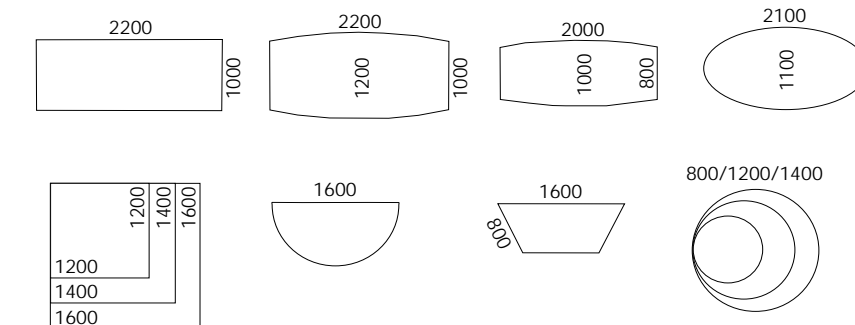

Przystawki i łączniki/ Add-on tables/ Anstellische

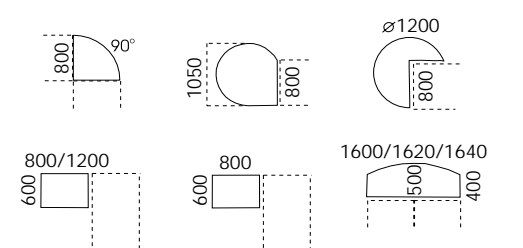

bench

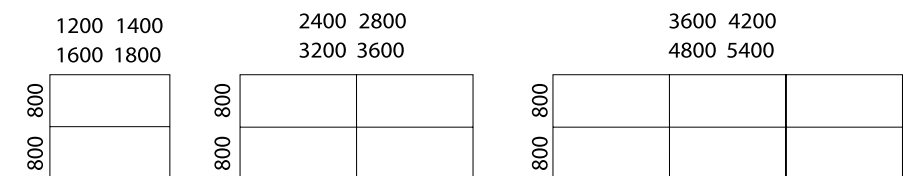

Accessories-eM

36
maro



1. Błat przesuwny
Sliding top
Schiebeplatte

2. Kanał kablowy poziomy uchylny
Fold-down horizontal
cable channel
Klappbarer Kabelkanal

3. Kanał kablowy poziomy stały
Fixed horizontal cable channel
Fester Kabelkanal

4. uchwyt kablowy
cable clamp
Kabelklemmer

5. Uchwyt kablowy
Cable holder
Kabelklemmer

6. Kanał kablowy elastyczny
Flexible cable spine
Flexibler Kabelkanal

7. Kanał kablowy pionowy
Vertical cable channel
Vertikaler Kabelkanal

8. Kanał kablowy - sprężyna
Cable channel - spring
Kabelkette vertikal

9. Kanał kablowy pionowy
wolnostojący otwarty
Freestanding vertical cable duct
(open)
Freistehender vertikaler Kabelkanal
(geöffnet)

10. Kanał kablowy pionowy
wolnostojący zamknięty
Freestanding vertical cable duct
(closed)
Freistehender vertikaler Kabelkanal
(geschlossen)

11. Mediaport obrotowy
Netbox turn
Strom-Daten-Box

12. Mediaport jednostronnie
uchylny
Netbox opened on one side
Netbox mit einseitiger Öffnung

13. Mediaport dwustronnie
uchylny
Netbox opened on both sides
Netbox mit beidseitiger Öffnung

14. Podstawa mobilna pod
komputer
PC - trolley
PC - Wagen

15. Wspornik pod komputer
z zabudową rastrową
PC-holder with protective cover
PC-Halter mit Sichtschutzblende

16. Zabudowa płytowa
Melamine modesty panel
Knieblende - Melamin

17. Zabudowa rastrowa
Perforated modesty panel
Knieblende - Lochblech

18. Akcesoria organizacyjne
Accessories
Zubehör

19. Akcesoria organizacyjne
Accessories
Zubehör

20. Przegródka podwieszana
z panelem tapicerowanym
Privacy screen with fabric pinboard
Frontsichtblende mit Pinpaneel

K-eM

L-Line

work with me here

38
maro

39
maro

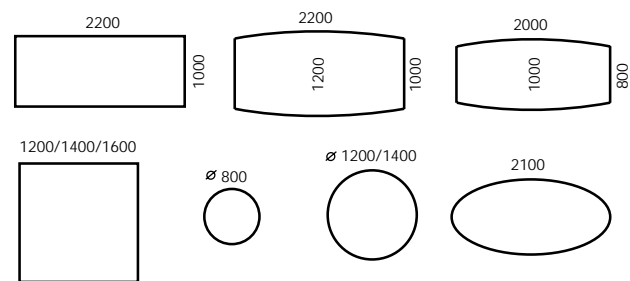

Stoly konferencyjne K-eM / Conference tables K-eM / Konferenztische K-eM



L-Line



40
maro

41
maro

conference

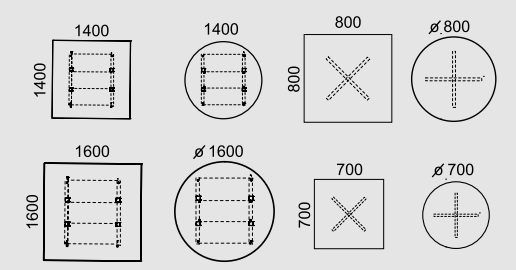
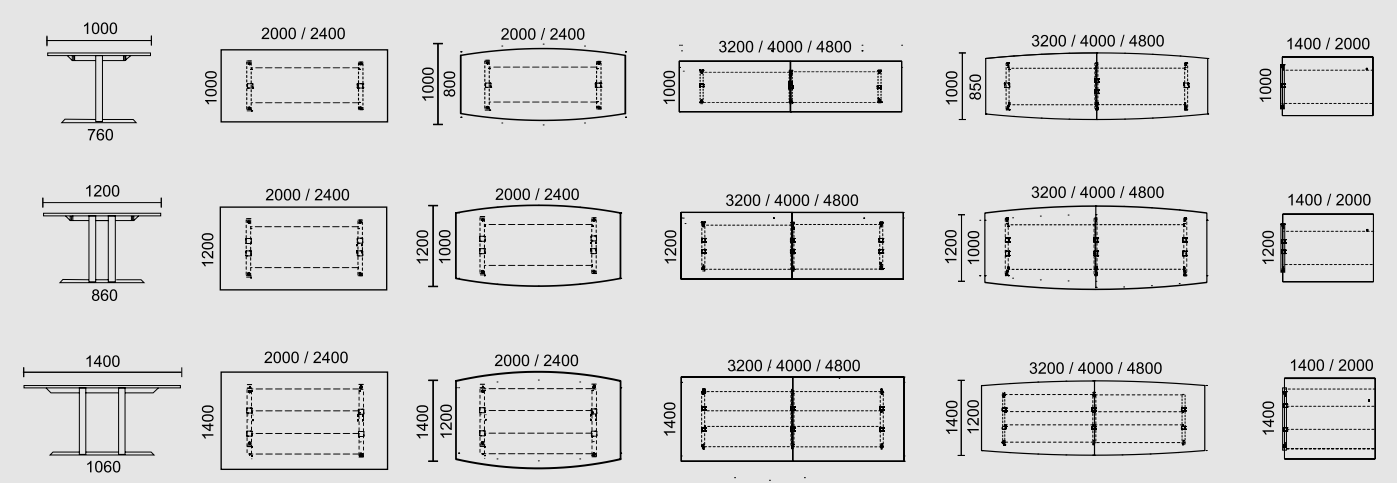

I-eM



42
maro

43
maro

your conference room

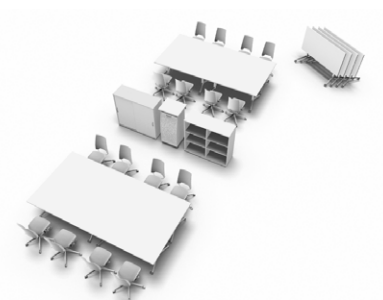
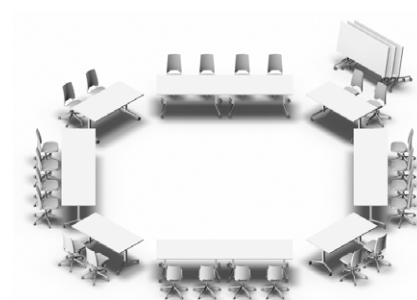

I-eM



44
maro

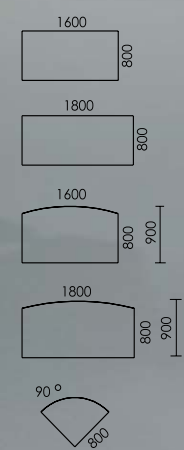

V-eM



45
maro

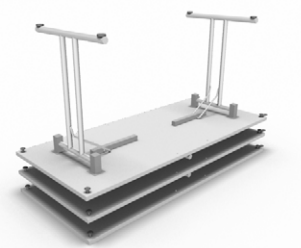
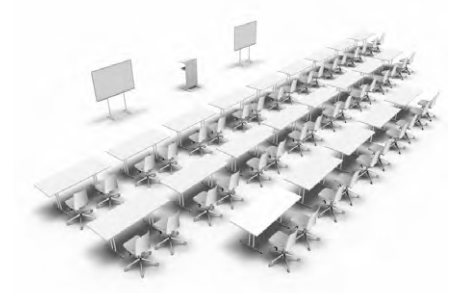
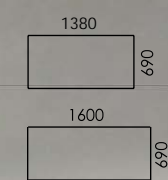

Archive

Nadstawki
Add-on units
Aufsatzschränke

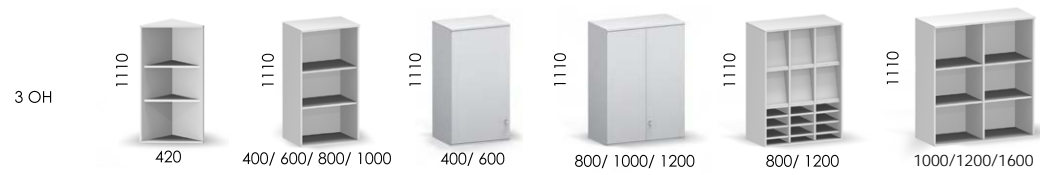
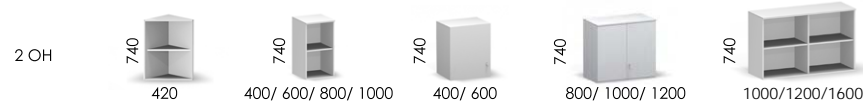

Szafy i regaly
Cabinets and open shelves
Schränke und Regale

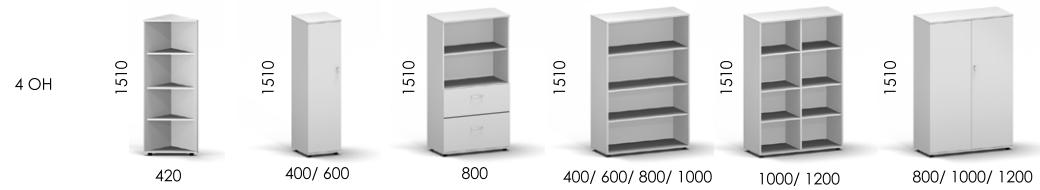
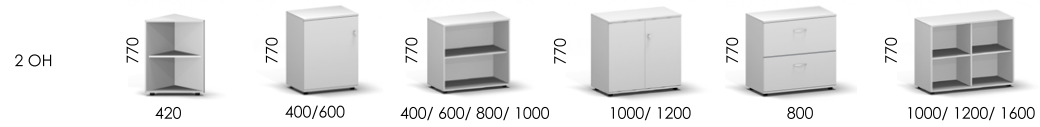

Zawias 110°
110° opening hinge
Türband 110° Öffnungswinkel



Zawias obiektywy 270°
270° opening hinge
Türband 270° Öffnungswinkel



Zamek baskwilowy
Cylinder lock
Zylinderschloss



Wieszak wysuwny
Pull-out clothes rail
Ausziehbare Kleiderstange



Półka metalowa z przegrodami, płytowa 25 mm, płytowa 18 mm
Metal shelf, melamine shelf 25 mm
melamine shelf 18 mm
Metall-, Melaminfachboden 25mm,
Melaminfachboden 18mm

Archive PROfessional cabinet



47
maro



Archive

PROfessional cabinet



Stopka poziomująca
H=30 mm
Glides with height
adjustment screw
H=30 mm
Gleiter mit
Verstellgleiter H=30 mm



Cokół metalowy
H=30 mm
Metal base
H=30 mm
Stahlsockel
H=30 mm



Stelaż metalowy 30x30
H=150 mm
Metal frame 30x30
H=150 mm
Metallgestell 30x30
H=150 mm



Stelaż metalowy Ø30
H=150 mm
Metal frame Ø30
H=150 mm
Metallgestell Ø30
H=150 mm



Szafa z drzwiami przesuwными
Sliding door cabinet
Schiebetürenschränk



Opcja: prowadnica biała
Option: white sliding guide
Option: weiße Führung



Szafka na teczki zawieszane
Extension for hanging files
Hängeregistratur - Auszug



Uchwyt do półki
Shelf holder
Fachträger



Poziomowanie szaf
Height adjustment for cabinets
Schränk- Nivellierung

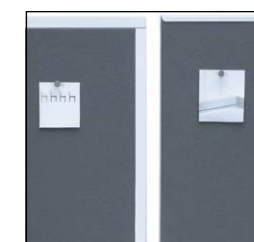

Pinpanel
Fabric pinboard
Pinpaneel

Szafy dwustronne / Double-sided cabinets / Sideboards mit zweiseitigen Schiebetüren

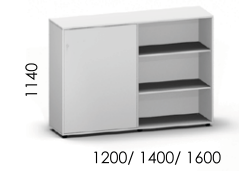
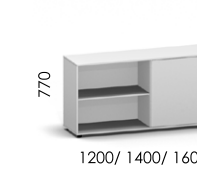

Nadstawki / Add-on units / Aufsatzschränke

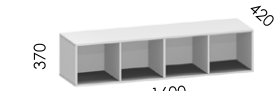
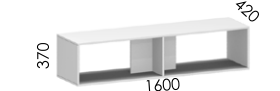
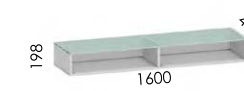

Szafy przesuwne - nadstawki / Sliding door add-on units / Schiebetürenaufsatzschränke

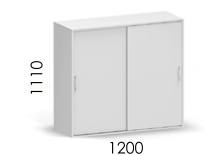
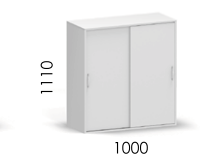
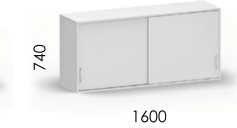
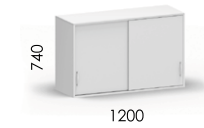
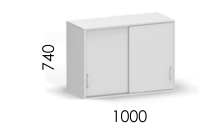

Szafy przesuwne / Sliding door cabinets / Schiebetürenschränke

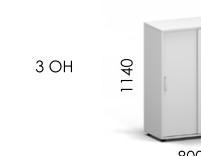
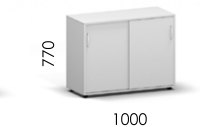

Szafy żaluzjowe - nadstawki / Shutter door add-on units / Rolladenaufsatzschränke

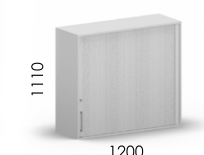
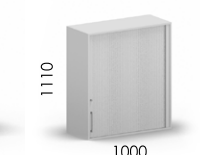
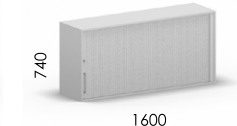
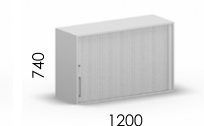
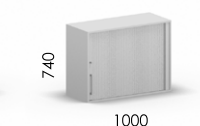
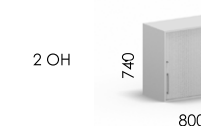

Szafy żaluzjowe / Shutter door cabinets / Rolladenschränke

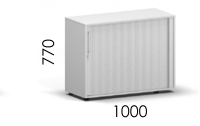

Archive



TOP pedestals

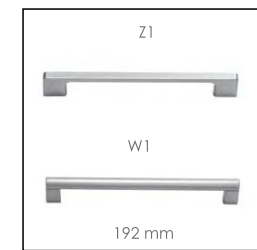

Uchwyty
Handles
Griffe

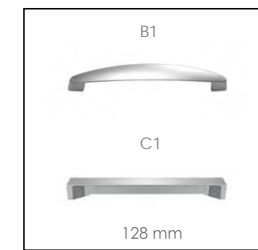

Uchwyty
Handles
Griffe



Gałka z zamkiem baskwilowym
Cylinder lock with turn-handle
Zylinderschloss mit Dreholive



Opcja: zamek szyfrowy
Option: Combination lock
Option: Zahlencodeschloss

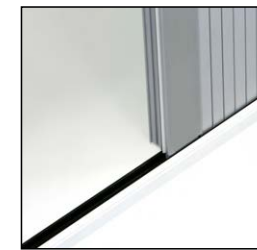

Prowadnica szafy żaluzjowej
Sliding guide
Führungsschiene

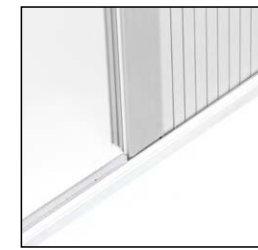

Opcja: prowadnica biała
Option: white sliding guide
Option: weiße Führungsschiene

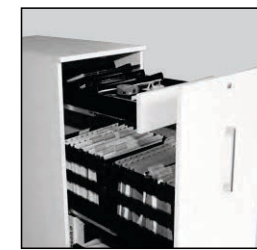

Szafka
Cupboard
Schublade



Uchwyt w kontenerze eM-Cargo
Handle eM-Cargo lower pedestals
Griff eM - Cargo container

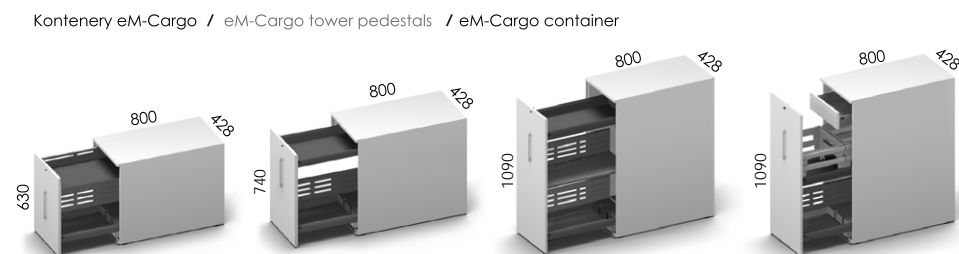
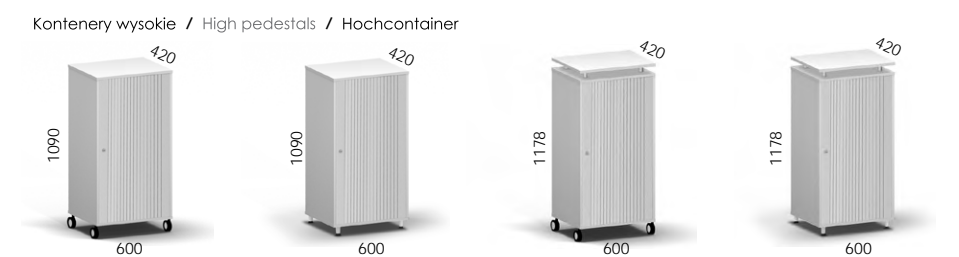
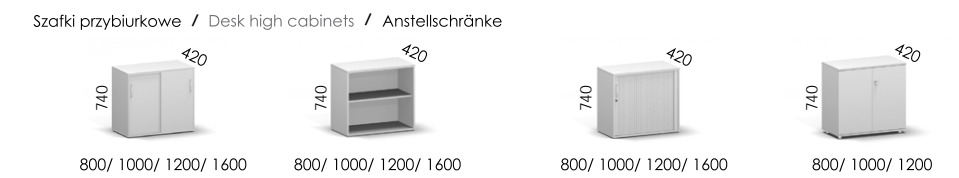
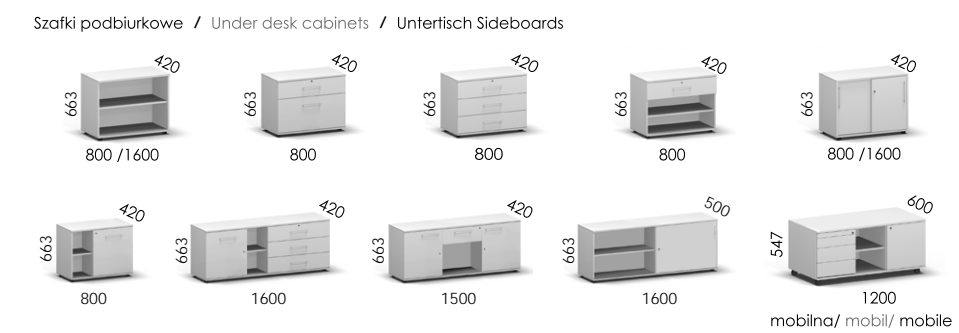
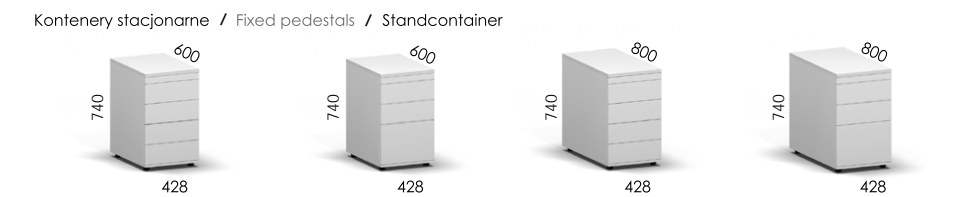
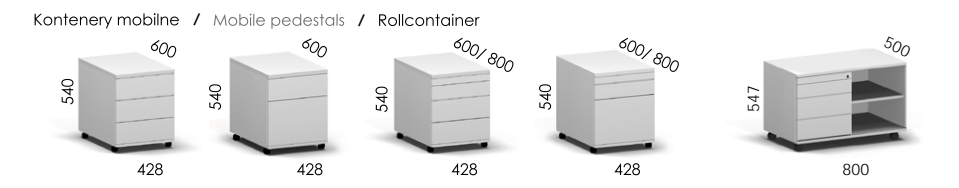

Kluczyk tamany
Folding key
Kippschlüssel

Uchwyt boczny
Side handle
Seitengriff

Piórnik
Pencil tray
Ausziehbrett

Przegroda ukośna
Diagonal divider
Schrägfachablage

Przegrody wzdłużne i poprzeczne
Lengthwise and cross dividers
Querunterteiler

Rama na teczki zawieszane
Hanging files
Hängeregistratur



Od 1991 roku Fabryka Mebli Biurowych MARO pozostaje liderem w tworzeniu wyposażenia dla nowoczesnych wnętrz biurowych. MARO jest synonimem najwyższej jakości i funkcjonalności połączonych ze światowym designem i innowacyjną techniką.

Koncentracja na budowaniu partnerstwa dzięki wysokim kompetencjom i doświadczeniu, ugruntowało opinię najlepszego, niezawodnego i godnego zaufania partnera. Międzynarodowe uznanie potwierdza nasza wieloletnia obecność na rynkach kilkunastu krajów świata.

Established in 1991 Maro Office Furniture is a pioneer in the European contract office marketplace developing innovative and desirable ranges for today's offices. Maro is synonymous with high quality, functionality, leading edge designs coupled with innovative technology.

Our focus is based on developing long term partnerships with our clients based in many countries around the world, through commitment to excellence, quality and investment in our team and manufacturing processes.

Seit 1991 ist MARO Büromöbel ein führendes Unternehmen im Bereich Lösungen für die moderne Büroeinrichtung. MARO steht für die Kombination von höchster Qualität, Funktionalität, ansprechendem Design und innovativer Technologie. Mit Kompetenz und Erfahrung haben wir uns über Jahre einen Ruf als zuverlässiger und vertrauenswürdiger Partner erarbeitet.

Unsere langjährige Präsenz in den Märkten mehrerer Länder bestätigt unsere hohe internationale Reputation.



Fabryka Mebli Biurowych MARO
 PL 62-052 Komorniki, ul. Fabianowska 100
 T +48 61 890 00 00, F +48 61 890 00 90
 www.maro.pl E maro@maro.pl

Kolory oraz wzory zaprezentowanych produktów mogą odbiegać od rzeczywistych. Producent zastrzega sobie prawo do zmian, poprawek, modyfikacji, zawieszenia, kontynuacji lub całkowitego wycofania wszystkich lub wybranych kolorów i wzorów zaprezentowanych produktów w pojedynczych przypadkach lub względem całej oferty w dowolnym czasie bez wcześniejszej informacji. Producent zastrzega sobie prawo do wprowadzania zmian w oferowanych produktach bez zmiany ogólnego wzornictwa. Niniejszy katalog nie stanowi prawnie wiążącej oferty i jest publikowany tylko w celach informacyjnych. Zamówienia mogą być składane wyłącznie na podstawie aktualnego cennika dostępnego u autoryzowanych dystrybutorów.

The colours and patterns of the presented products may differ from the real ones. The Manufacturer reserves the right to change, amend, modify, suspend, continue or terminate all or any colour or pattern of the presented products either in an individual case or in general, at any time without notice. The manufacturer reserves the right to introduce alterations in the products without changing the general design. The presented catalogue does not constitute a legally binding offer and it is published solely for information purposes only. Orders may be placed only on the basis of the current price list available at authorised distributors.



bam büromöbel Handels GmbH
 Richard-Wagner-Str. 48
 10585 Berlin
 T +49 30 321 1228
 service@bam-bueromoebel.de
 www.bam-bueromoebel.de

Osiągnięcia
 Leistungen
 Achievements



1996, 1997, 1999,
 2001, 2003, 2004



Wielki Złoty Medal
 2004



1995, 1996, 1997, 1998,
 1999, 2000, 2005



1998, 1999, 2007, 2008,
 2009, 2013



© MARO

Wszystkie wzory chronione w Urzędzie Patentowym RP