

# office system

-eM

O-eM

K-eM

F-eM

Q-eM

A-eM

Lano - C

Lano - T

Lano - E

Beta

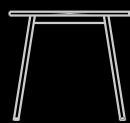
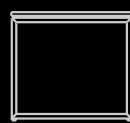
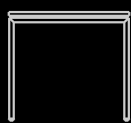
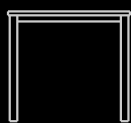



# office system

-eM

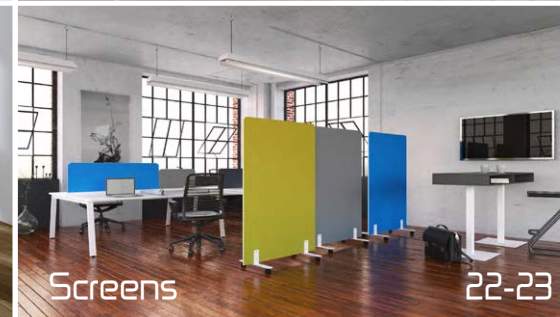



Q-eM



04  
marzo



05  
marzo





bench

06  
maro



07  
maro





# Work & shared area

bench



08  
maro

09  
maro

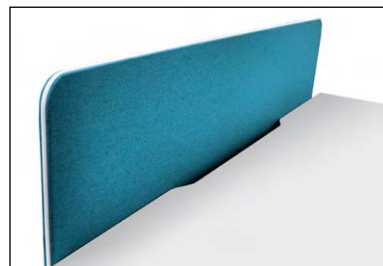
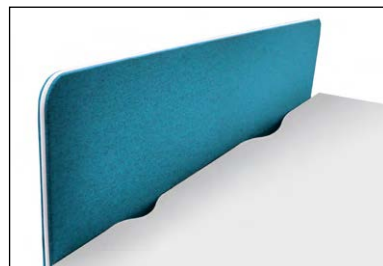
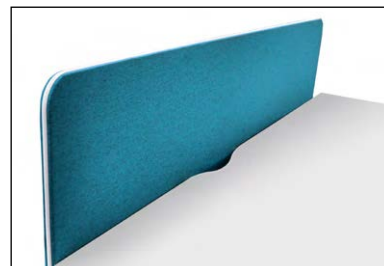

more info [maro.pl](http://maro.pl)





F-eM

A-eM



10  
maro

11  
maro



# F-eM

## your place of work

12  
maro

13  
maro



more info [maro.pl](http://maro.pl)



# K-eM



14  
maro



15  
maro



740-820



650-850

more info [maro.pl](http://maro.pl)

800/1000/1200/1400  
1600/1800/2000



1600/1800/2000



1600/1800



1600/1800/2000



1600/1800/2000



1600/1800/2000





locker

A-eM, privacy screen

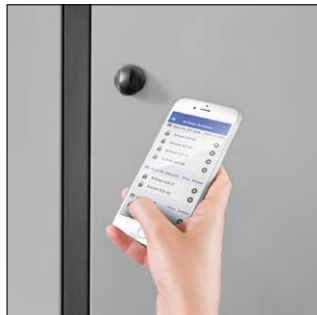

17  
marzo

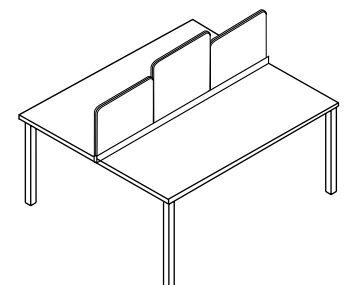
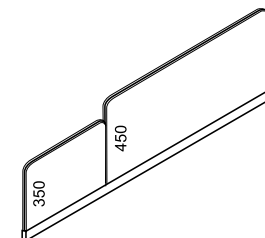
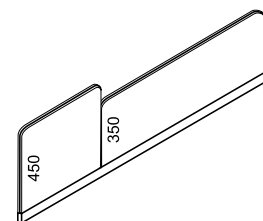
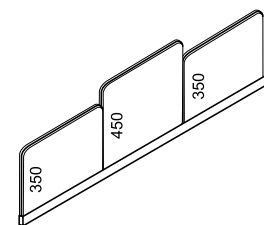
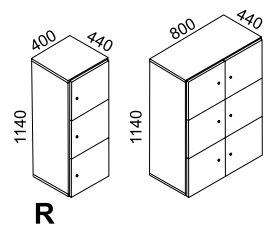
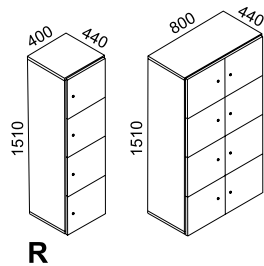
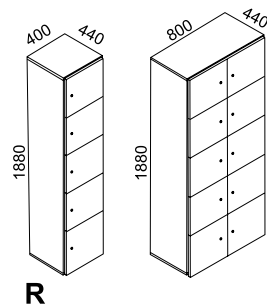



F-eM

18  
maro

19  
maro



O-eM





20  
maro



21  
maro

# dynamic communication



more info [maro.pl](http://maro.pl)







22  
maro



23  
maro

## Accessories-eM

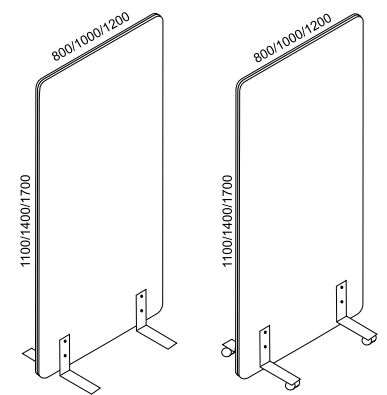
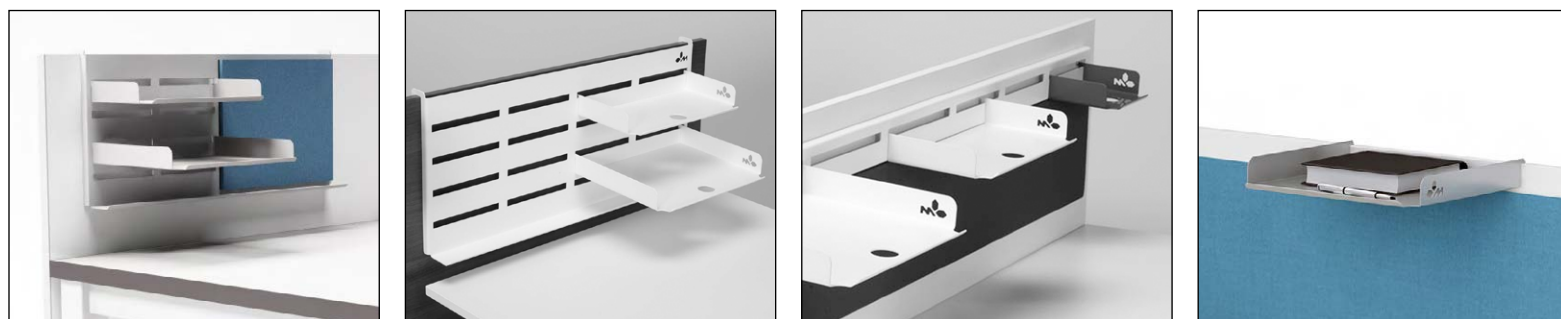

# Screens



24  
marzo

25  
marzo

# Lano-T

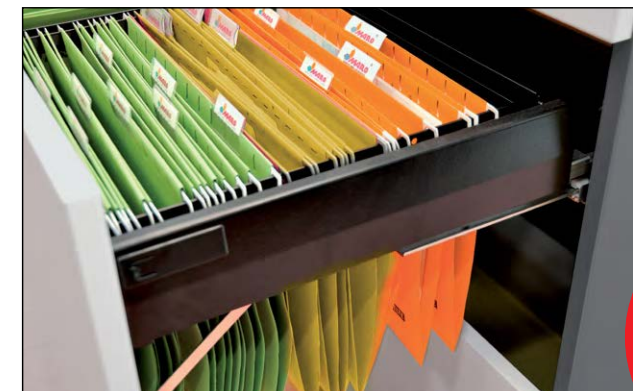



# Lano-T

26  
marzo

27  
marzo





# Lano-E

28  
maro



29  
maro



Panel sterujące/ Control panel/ Höhensteuerung

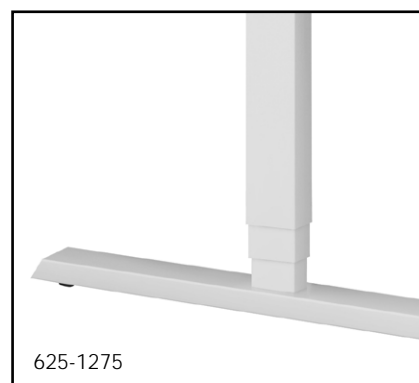

625-1275

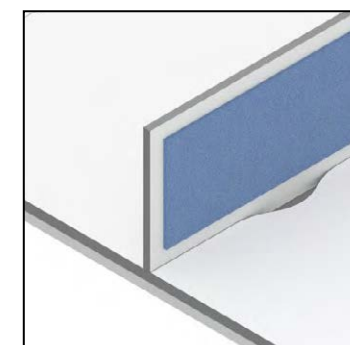
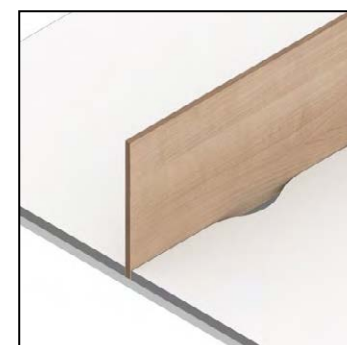



# Lano-C

# Screen S30

600 / 800 / 1000 / 1200 / 1400 / 1600

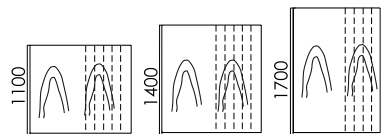
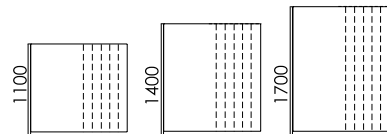

600 / 800 / 1000 / 1200 / 1400 / 1600

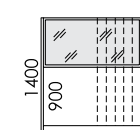

600 / 800 / 1000 / 1200

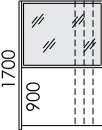

30  
maro

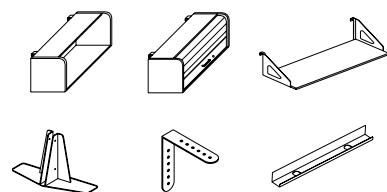

31  
maro





# Beta

32  
maro

33  
maro

your style

more info [maro.pl](http://maro.pl)





O-eM

K-eM

F-eM

Q-eM

A-eM

Lano - C

Lano - T

Lano - E

Beta

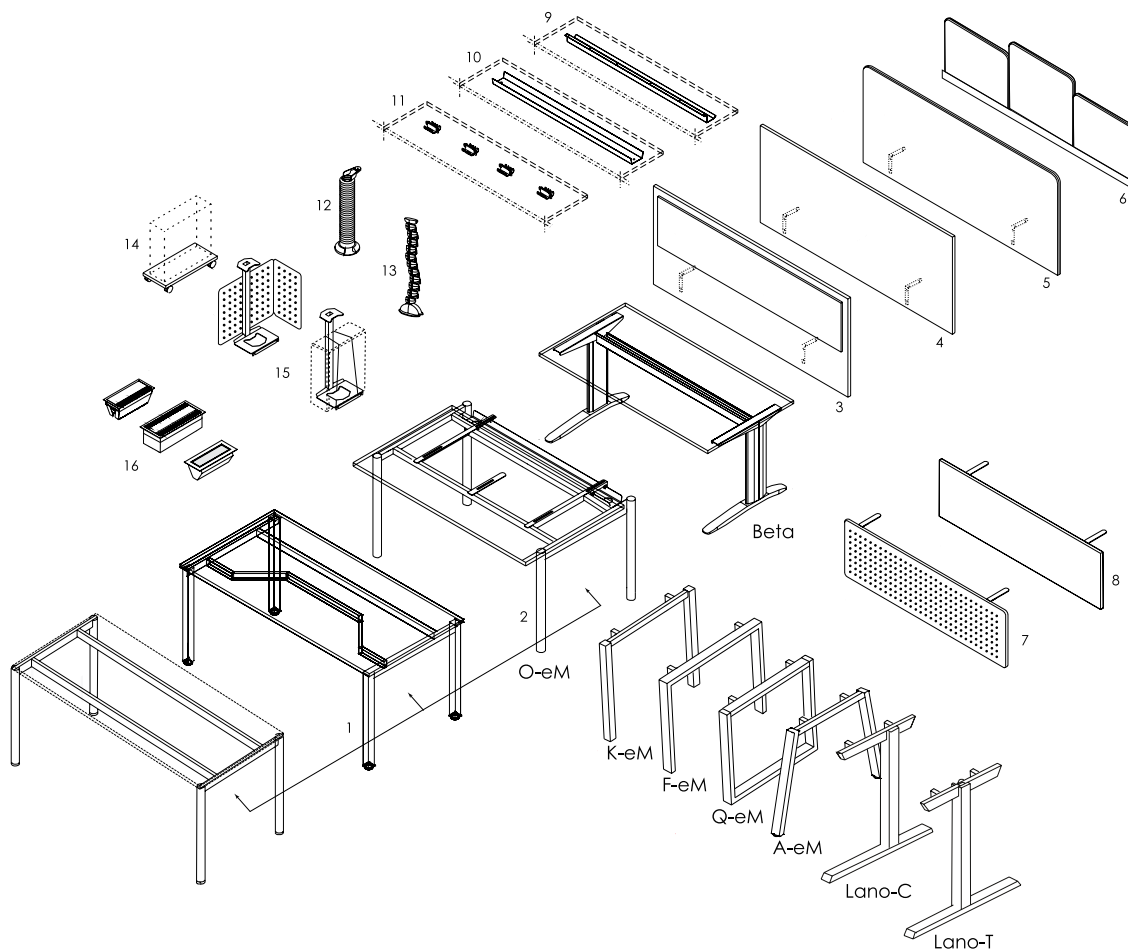
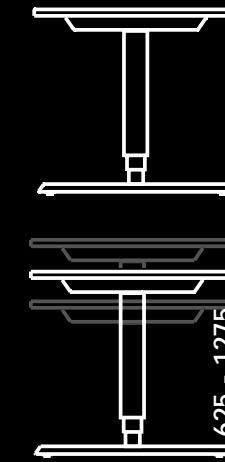
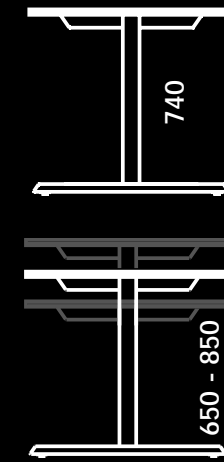
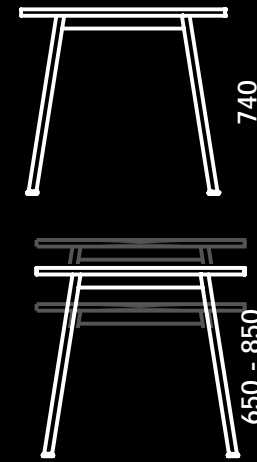
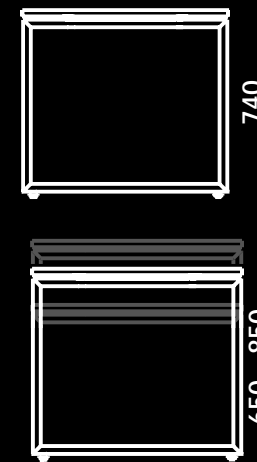
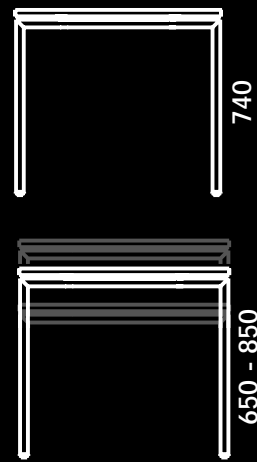
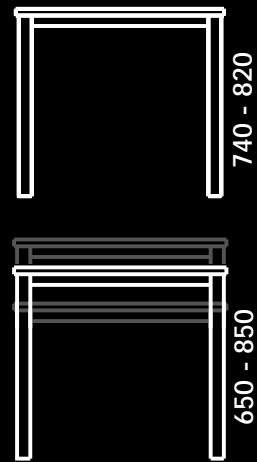
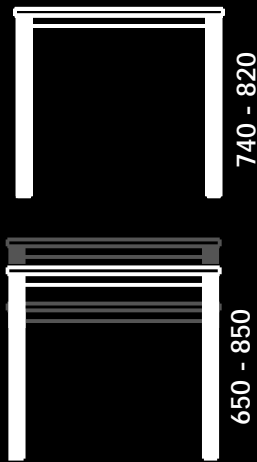

1. Stelaż ergonomiczny/ Ergonomic desk frame/ Ergonomisches Schreibtischgestell

2. Blat przesuwny/ Sliding top/ Schiebeplatte

3. Przegroda podwieszana z pinpanelem/ Privacy screen with fabric pinboard/ Frontsichtblende mit Pinpaneel

4. Przegroda podwieszana/ Basic privacy screen/ Standard Frontsichtblende

5. Przegroda tapicerowana/ Upholstered privacy screen/ Frontsichtblende mit Stoffbezug

6. Przegroda dzielona/ Multi privacy screens/ Multi Frontsichtblenden

7. Zabudowa rastrowa/ Perforated modesty panel/ Knieblende - Lochblech

8. Zabudowa płytowa/ Melamine modesty panel/ Knieblende - Melamin

9. Kanał kablowy poziomy stały/ Fold-down horizontal cable channel/ Klappbarer Kabelkanal

10. Kanał kablowy poziomy uchylny/ Fixed horizontal cable channel/ Fester Kabelkanal

11. Uchwyty kablowe/ Cable clamps/ Kabelklemmer

12. Elastyczny kanał kablowy/ Flexible cable spine/ Flexibler Kabelkanal

13. Kanał kablowy - sprężyna/ Cable channel - spring/ Kabelkette vertikal

14. Mobilna podstawa pod komputer/ PC-trolley/ PC-Wagen

15. Wsporniki pod komputer/ PC-holder/ PC-Halter

16. Mediaporty/ Netbox/ Strom-Daten-Box

Biurka/ Desks/ Schreibtische

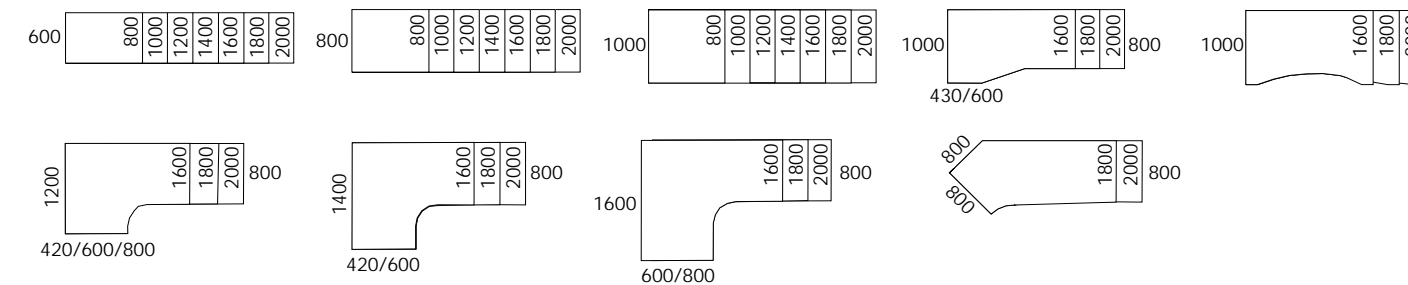

Stoły konferencyjne/ Conference tables/ Konferenztische

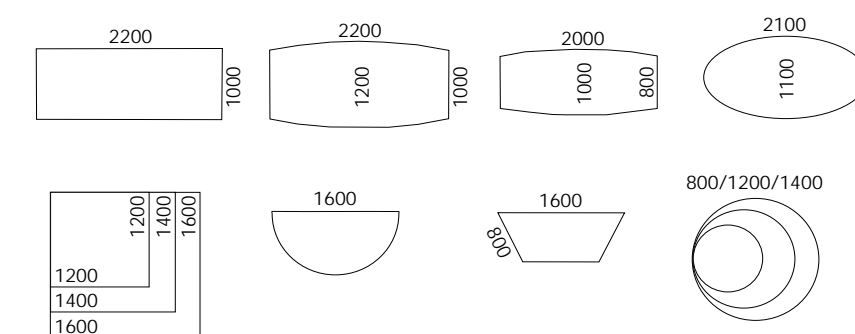

Przystawki i łączniki/ Add-on tables/ Anstellische

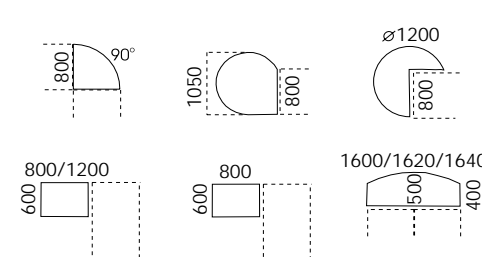

bench

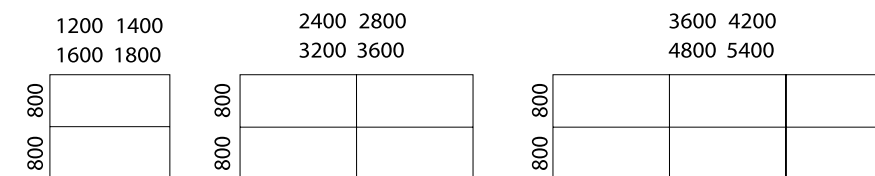



# Accessories-eM

36  
maro



1. Błat przesuwny  
Sliding top  
Schiebeplatte

2. Kanał kablowy poziomy uchylny  
Fold-down horizontal  
cable channel  
Klappbarer Kabelkanal

3. Kanał kablowy poziomy stały  
Fixed horizontal cable channel  
Fester Kabelkanal

4. uchwyt kablowy  
cable clamp  
Kabelklemmer

5. Uchwyt kablowy  
Cable holder  
Kabelklemmer

6. Kanał kablowy elastyczny  
Flexible cable spine  
Flexibler Kabelkanal

7. Kanał kablowy pionowy  
Vertical cable channel  
Vertikaler Kabelkanal

8. Kanał kablowy - sprężyna  
Cable channel - spring  
Kabelkette vertikal

9. Kanał kablowy pionowy  
wolnostojący otwarty  
Freestanding vertical cable duct  
(open)  
Freistehender vertikaler Kabelkanal  
(geöffnet)

10. Kanał kablowy pionowy  
wolnostojący zamknięty  
Freestanding vertical cable duct  
(closed)  
Freistehender vertikaler Kabelkanal  
(geschlossen)

11. Mediaport obrotowy  
Netbox turn  
Strom-Daten-Box

12. Mediaport jednostronnie  
uchylny  
Netbox opened on one side  
Netbox mit einseitiger Öffnung

13. Mediaport dwustronnie  
uchylny  
Netbox opened on both sides  
Netbox mit beidseitiger Öffnung

14. Podstawa mobilna pod  
komputer  
PC - trolley  
PC - Wagen

15. Wspornik pod komputer  
z zabudową rastrową  
PC-holder with protective cover  
PC-Halter mit Sichtschutzblende

16. Zabudowa płytowa  
Melamine modesty panel  
Knieblende - Melamin

17. Zabudowa rastrowa  
Perforated modesty panel  
Knieblende - Lochblech

18. Akcesoria organizacyjne  
Accessories  
Zubehör

19. Akcesoria organizacyjne  
Accessories  
Zubehör

20. Przegroda podwieszana  
z panelem tapicerowanym  
Privacy screen with fabric pinboard  
Frontsichtblende mit Pinpaneel



# K-eM

# L-Line

work with me here

38  
maro

39  
maro

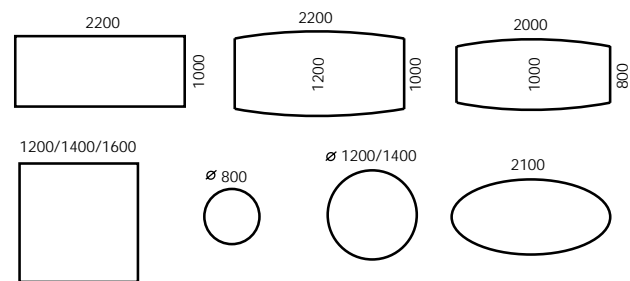

Stoly konferencyjne K-eM / Conference tables K-eM / Konferenztische K-eM



L-Line



# L-Line



40  
maro

41  
maro

## conference

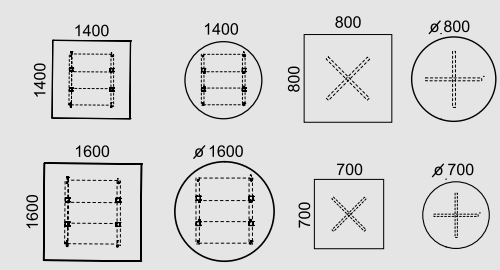
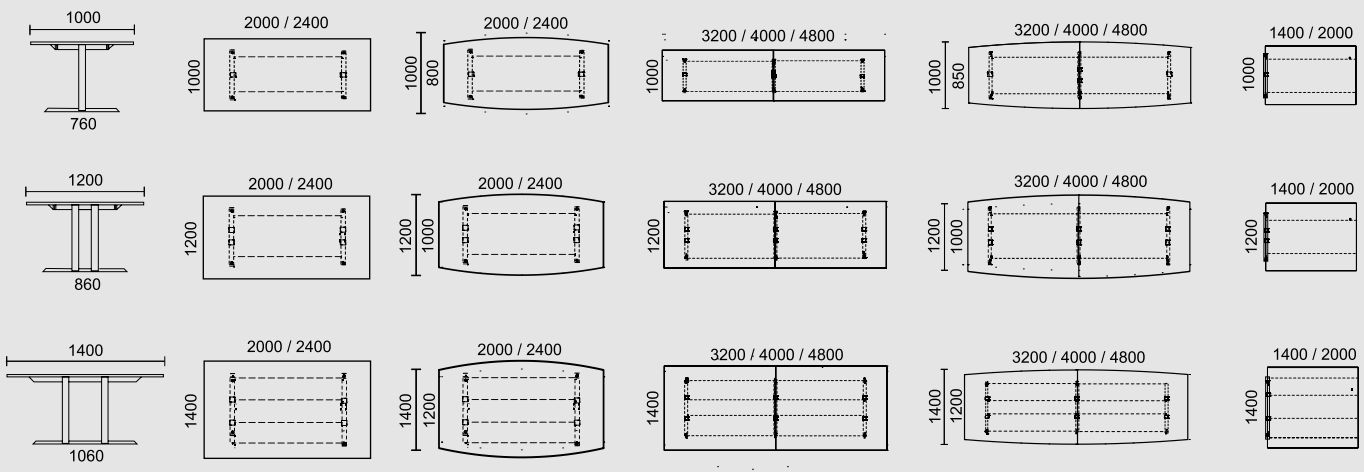



I-eM



42  
maro

43  
maro

your conference room

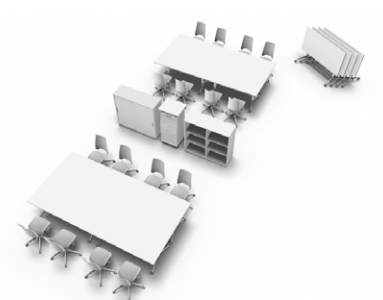
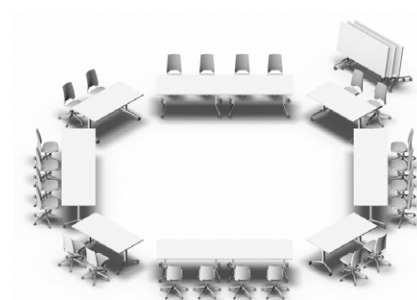



# I-eM



44  
maro

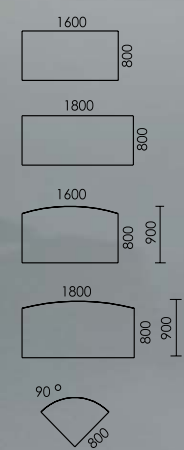

# V-eM

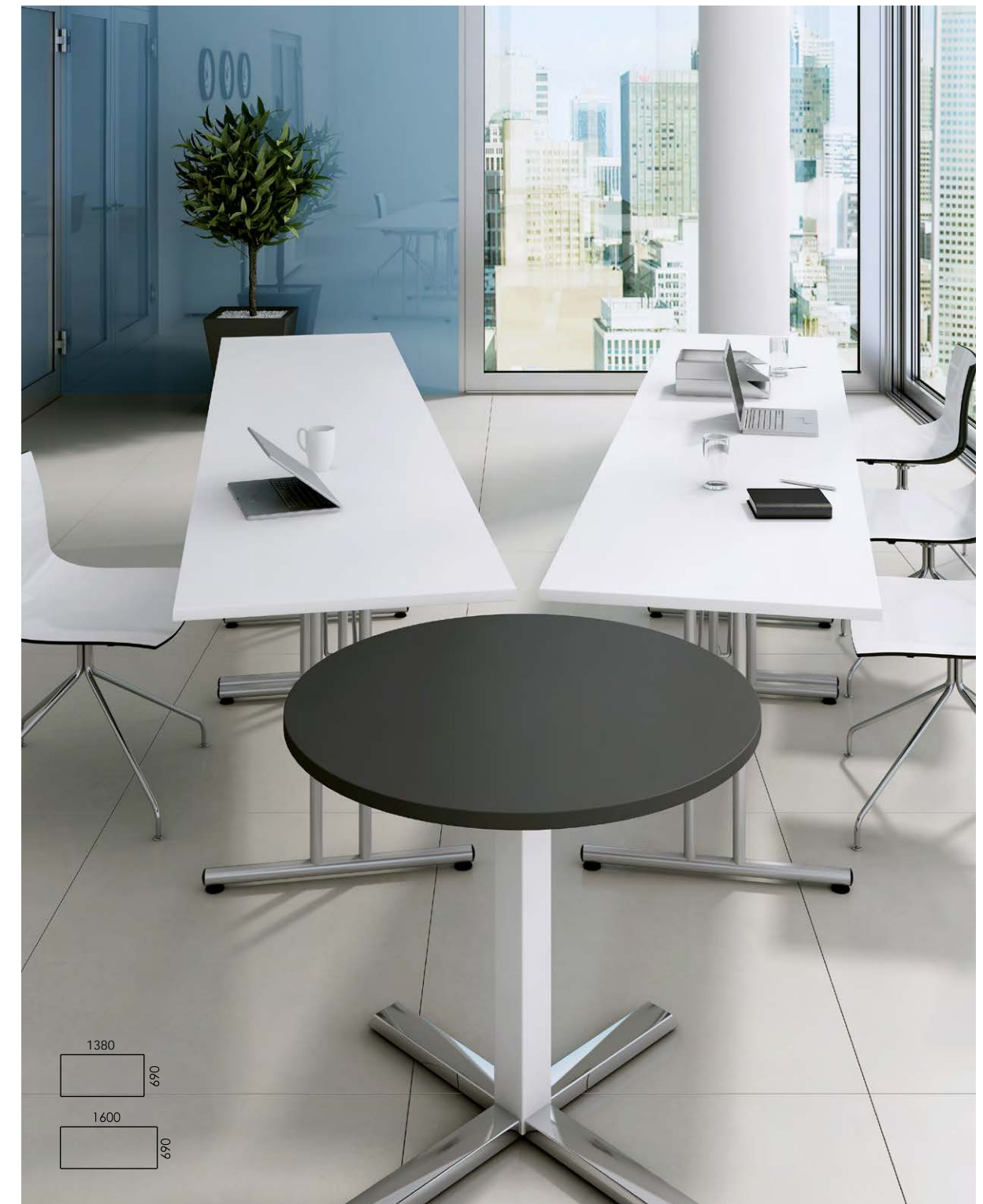

45  
maro

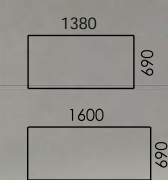



# Archive

Nadstawki  
Add-on units  
Aufsatzschränke

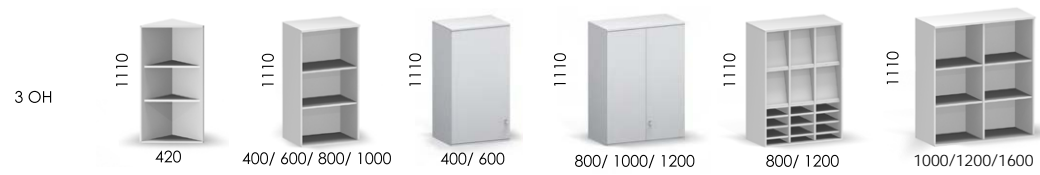
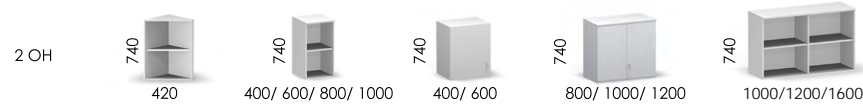

Szafy i regaly  
Cabinets and open shelves  
Schränke und Regale

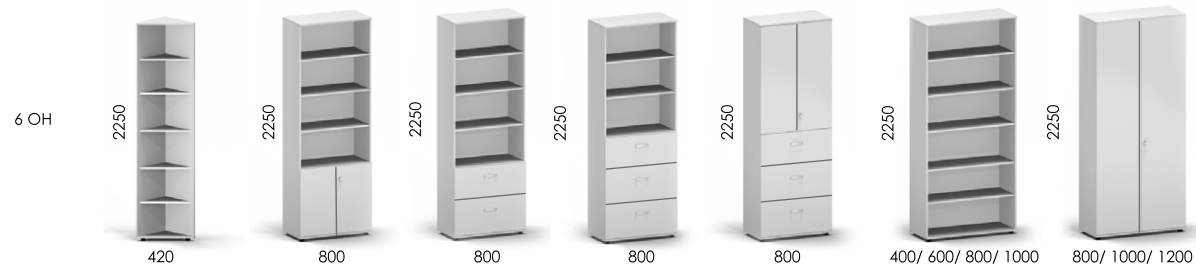
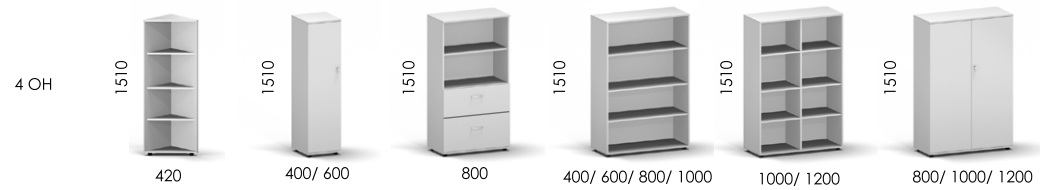
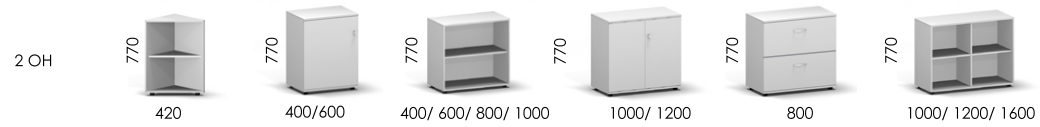

Zawias 110°  
110° opening hinge  
Türband 110° Öffnungswinkel



Zawias obrotowy 270°  
270° opening hinge  
Türband 270° Öffnungswinkel



Zamek baskwilowy  
Cylinder lock  
Zylinderschloss

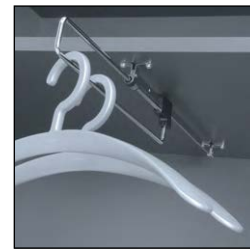

Wieszak wysuwny  
Pull-out clothes rail  
Ausziehbare Kleiderstange



Półka metalowa z przegrodami, płytowa 25 mm, płytowa 18 mm  
Metal shelf, melamine shelf 25 mm  
melamine shelf 18 mm  
Metall-, Melaminfachboden 25mm,  
Melaminfachboden 18mm

# Archive PROfessional cabinet





# Archive

# PROfessional cabinet



Stopka poziomująca  
H=30 mm  
Glides with height  
adjustment screw  
H=30 mm  
Gleiter mit  
Verstellgleiter H=30 mm



Cokół metalowy  
H=30 mm  
Metal base  
H=30 mm  
Stahlsockel  
H=30 mm



Stelaż metalowy 30x30  
H=150 mm  
Metal frame 30x30  
H=150 mm  
Metallgestell 30x30  
H=150 mm



Stelaż metalowy Ø30  
H=150 mm  
Metal frame Ø30  
H=150 mm  
Metallgestell Ø30  
H=150 mm



Szafa z drzwiami przesuwными  
Sliding door cabinet  
Schiebetürenschränk



Opcja: prowadnica biała  
Option: white sliding guide  
Option: weiße Führung



Szafka na teczki zawieszane  
Extension for hanging files  
Hängeregistratur - Auszug



Uchwyt do półki  
Shelf holder  
Fachträger



Poziomowanie szaf  
Height adjustment for cabinets  
Schränk- Nivellierung

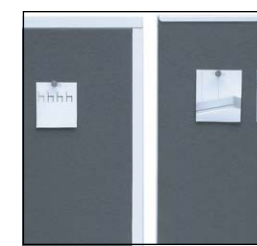

Pinpanel  
Fabric pinboard  
Pinpaneel

## Szafy dwustronne / Double-sided cabinets / Sideboards mit zweiseitigen Schiebetüren

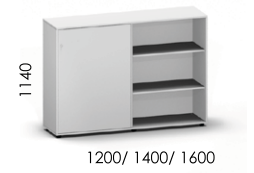
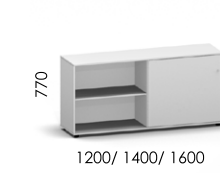

## Nadstawki / Add-on units / Aufsatzschränke

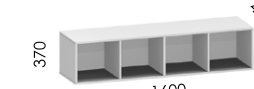
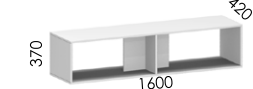
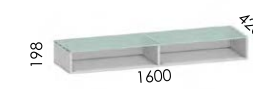

## Szafy przesuwne - nadstawki / Sliding door add-on units / Schiebetürenaufsatzschränke

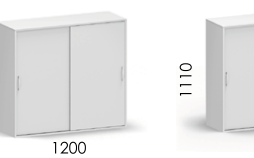
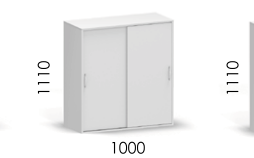
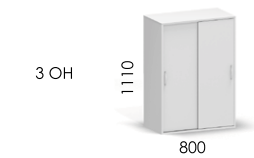
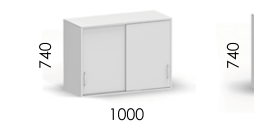
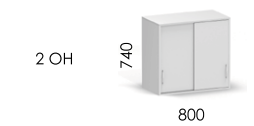

## Szafy przesuwne / Sliding door cabinets / Schiebetürenschränke

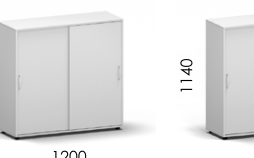
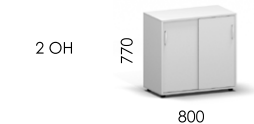

## Szafy żaluzjowe - nadstawki / Shutter door add-on units / Rolladenaufsatzschränke

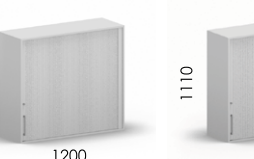
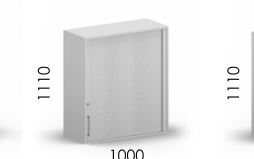
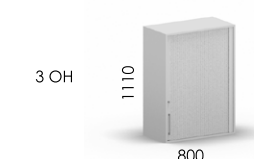
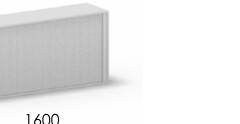
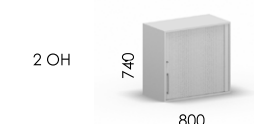

## Szafy żaluzjowe / Shutter door cabinets / Rolladenschränke

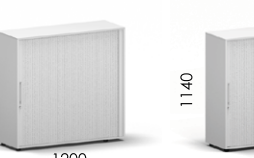



# Archive



# TOP pedestals

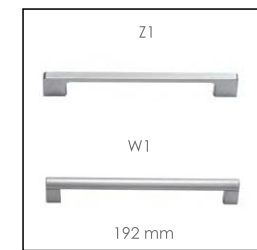

Uchwyty  
Handles  
Griffe

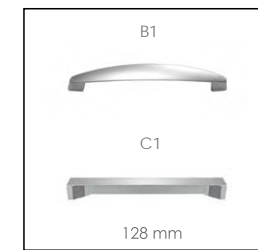

Uchwyty  
Handles  
Griffe



Gałka z zamkiem baskwilowym  
Cylinder lock with turn-handle  
Zylinderschloss mit Dreholive



Opcja: zamek szyfrowy  
Option: Combination lock  
Option: Zahlencodeschloss



Prowadnica szafy żaluzjowej  
Sliding guide  
Führungsschiene

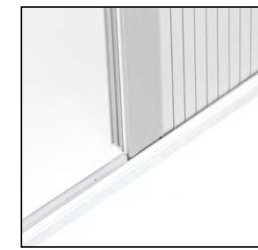

Opcja: prowadnica biała  
Option: white sliding guide  
Option: weiße Führungsschiene

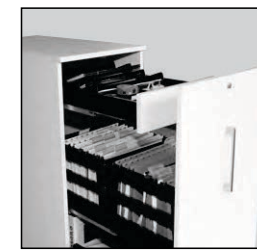

Szafka  
Cupboard  
Schublade



Uchwyt w kontenerze eM-Cargo  
Handle eM-Cargo lower pedestals  
Griff eM - Cargo container

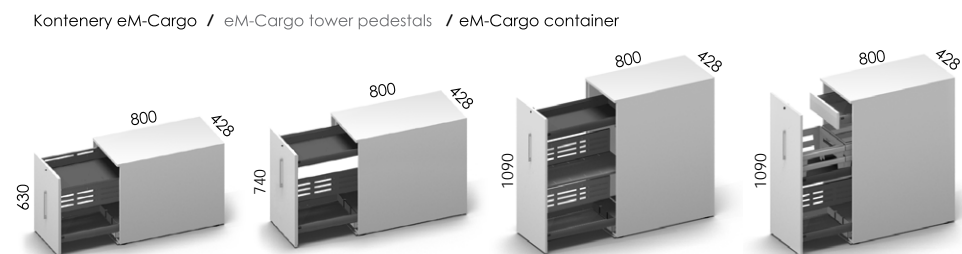
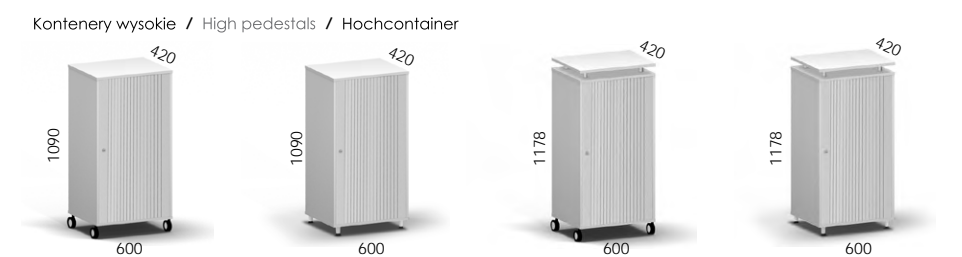
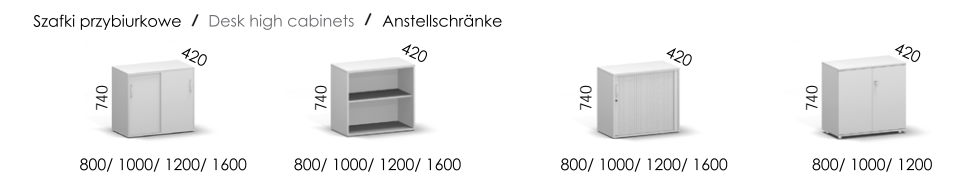
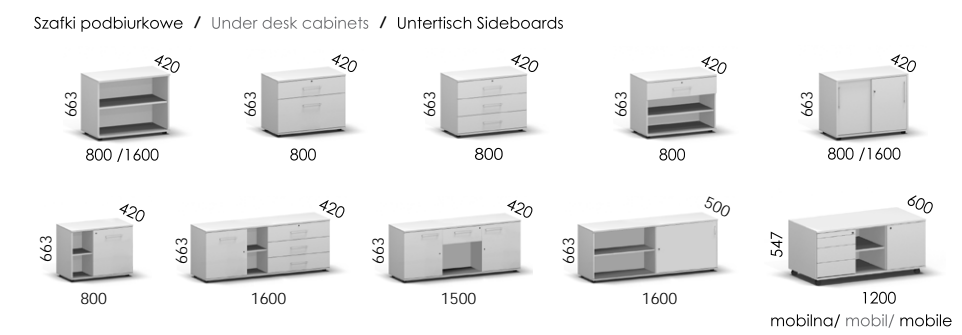
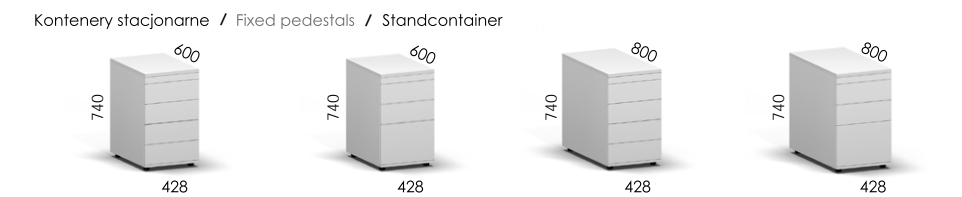
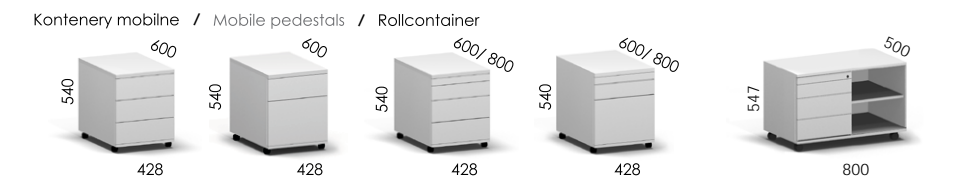

Kluczyk tamany  
Folding key  
Kippschlüssel

Uchwyt boczny  
Side handle  
Seitengriff

Piórnik  
Pencil tray  
Ausziehbrett

Przegroda ukośna  
Diagonal divider  
Schrägfachablage

Przegrody wzdłużne i poprzeczne  
Lengthwise and cross dividers  
Querunterteiler

Rama na teczki zawieszane  
Hanging files  
Hängeregistratur





Od 1991 roku Fabryka Mebli Biurowych MARO pozostaje liderem w tworzeniu wyposażenia dla nowoczesnych wnętrz biurowych. MARO jest synonimem najwyższej jakości i funkcjonalności połączonych ze światowym designem i innowacyjną techniką.

Koncentracja na budowaniu partnerstwa dzięki wysokim kompetencjom i doświadczeniu, ugruntowało opinię najlepszego, niezawodnego i godnego zaufania partnera. Międzynarodowe uznanie potwierdza nasza wieloletnia obecność na rynkach kilkunastu krajów świata.

Established in 1991 Maro Office Furniture is a pioneer in the European contract office marketplace developing innovative and desirable ranges for today's offices. Maro is synonymous with high quality, functionality, leading edge designs coupled with innovative technology.

Our focus is based on developing long term partnerships with our clients based in many countries around the world, through commitment to excellence, quality and investment in our team and manufacturing processes.

Seit 1991 ist MARO Büromöbel ein führendes Unternehmen im Bereich Lösungen für die moderne Büroeinrichtung. MARO steht für die Kombination von höchster Qualität, Funktionalität, ansprechendem Design und innovativer Technologie. Mit Kompetenz und Erfahrung haben wir uns über Jahre einen Ruf als zuverlässiger und vertrauenswürdiger Partner erarbeitet.

Unsere langjährige Präsenz in den Märkten mehrerer Länder bestätigt unsere hohe internationale Reputation.



Fabryka Mebli Biurowych MARO  
 PL 62-052 Komorniki, ul. Fabianowska 100  
 T +48 61 890 00 00, F +48 61 890 00 90  
 www.maro.pl E maro@maro.pl

Kolory oraz wzory zaprezentowanych produktów mogą odbiegać od rzeczywistych. Producent zastrzega sobie prawo do zmian, poprawek, modyfikacji, zawieszenia, kontynuacji lub całkowitego wycofania wszystkich lub wybranych kolorów i wzorów zaprezentowanych produktów w pojedynczych przypadkach lub względem całej oferty w dowolnym czasie bez wcześniejszej informacji. Producent zastrzega sobie prawo do wprowadzania zmian w oferowanych produktach bez zmiany ogólnego wzornictwa. Niniejszy katalog nie stanowi prawnie wiążącej oferty i jest publikowany tylko w celach informacyjnych. Zamówienia mogą być składane wyłącznie na podstawie aktualnego cennika dostępnego u autoryzowanych dystrybutorów.

The colours and patterns of the presented products may differ from the real ones. The Manufacturer reserves the right to change, amend, modify, suspend, continue or terminate all or any colour or pattern of the presented products either in an individual case or in general, at any time without notice. The manufacturer reserves the right to introduce alterations in the products without changing the general design. The presented catalogue does not constitute a legally binding offer and it is published solely for information purposes only. Orders may be placed only on the basis of the current price list available at authorised distributors.



bam büromöbel Handels GmbH  
 Richard-Wagner-Str. 48  
 10585 Berlin  
 T +49 30 321 1228  
 service@bam-bueromoebel.de  
 www.bam-bueromoebel.de

Osiągnięcia  
 Leistungen  
 Achievements



1996, 1997, 1999,  
 2001, 2003, 2004



Wielki Złoty Medal  
 2004



1995, 1996, 1997, 1998,  
 1999, 2000, 2005



© MARO

Wszystkie wzory chronione w Urzędzie Patentowym RP