

#CaimiSafeDesign

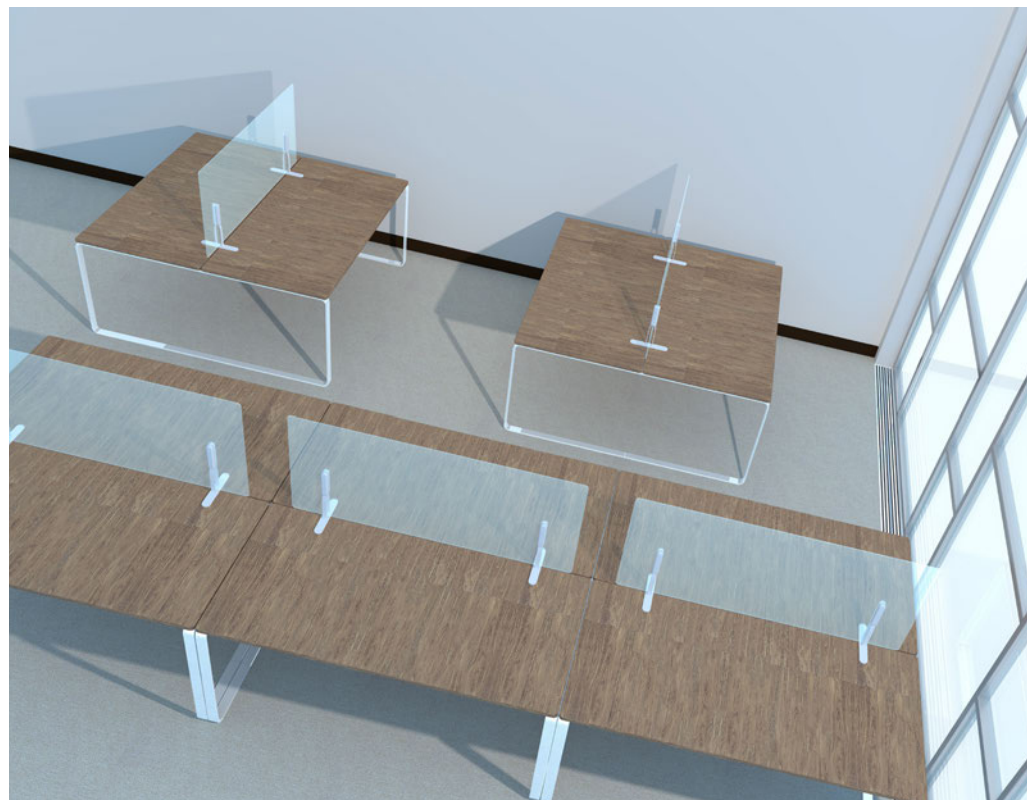

I pannelli divisori sono realizzati in metacrilato trasparente. I supporti sono realizzati in acciaio verniciato con polveri epossidiche e tecnopolimero e sono disponibili nei colori bianco opaco o grigio argento. I supporti consentono di sostenere i pannelli che possono essere semplicemente appoggiati al piano per consentirne lo spostamento o fissati al piano tramite morsetti, piastre o viti.

Screen partitions made by transparent methacrylate. Brackets in powder-coated steel and high-tech polymer, available in matt white or silver gray colors. Different types of brackets: for top stands to be able to move the panels on the desk or brackets fixed on the top with clamps, plates or screws.

Les panneaux de séparation sont réalisés en méthacrylate transparent. Les supports en acier peint époxy et tecnopolymère sont disponibles en couleur blanc mat ou gris argenté. Les supports permettent de soutenir les panneaux qui peuvent être simplement posés sur le bureau pour favoriser le déplacement ou fixés au plateau par des étaux, par des plaques ou vis.

## Accessories:

Coppia staffe in acciaio verniciato con polveri epossidiche per fissaggio sopra il piano della scrivania tramite viti (non incluse).

Pair of brackets in powder-coated steel to be fixed on the desk top with screws (not included).

Paire d'étriers en acier peint époxy pour fixation sur le bureau par des vis (pas incluses).

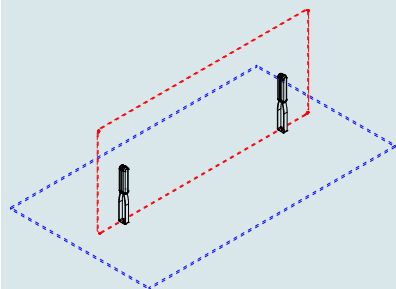
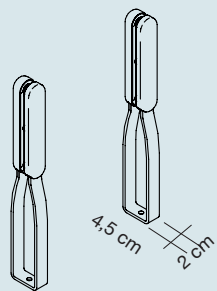

Coppia staffe in acciaio verniciato con polveri epossidiche per fissaggio sotto al piano fra due scrivanie.

Pair of brackets in powder-coated steel to be fixed under the desk top between two desks.

Paire d'étriers en acier peint époxy pour fixation au-dessous du plateau entre deux bureaux.

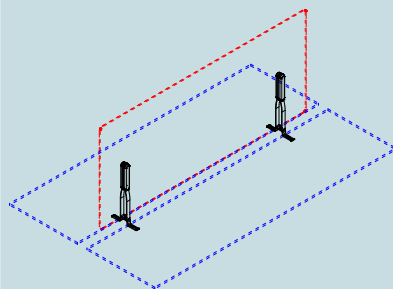
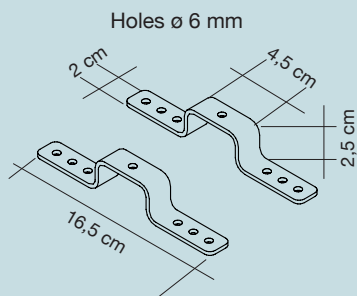

Coppia staffe con morsetto in acciaio verniciato con polveri epossidiche per fissaggio al piano della scrivania.

Pair of brackets with clamp in powder-coated steel for connection to the desk top.

Paire d'étriers avec étau en acier peint époxy pour fixation au bureau.

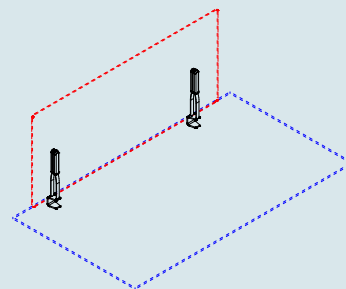
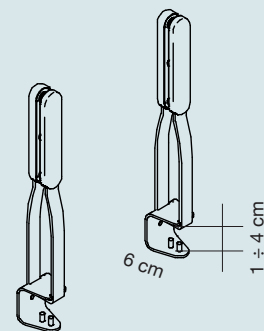

Coppia staffe in acciaio verniciato con polveri epossidiche per fissaggio sotto il piano della scrivania tramite viti (non incluse).

Pair of brackets in powder-coated steel to be fixed under the desk top with screws (not included).

Paire d'étriers en acier peint époxy pour fixation au dessous du le bureau par des vis (pas incluses).

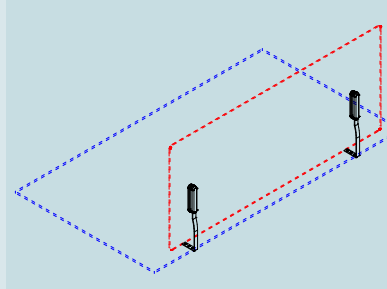
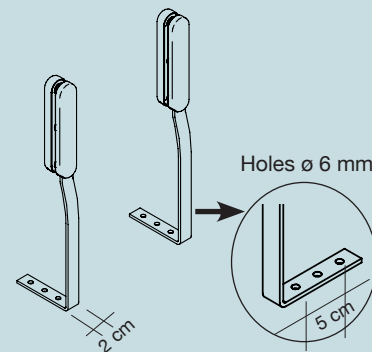

Coppia staffe con base in acciaio verniciato con polveri epossidiche per appoggio al piano della scrivania.

Pair of brackets with base in powder-coated steel for desk top stand.

Paire d'étriers avec base en acier peint époxy à poser sur le dessus du bureau.

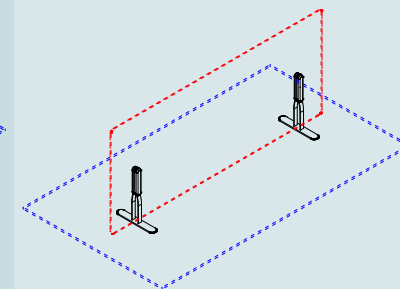
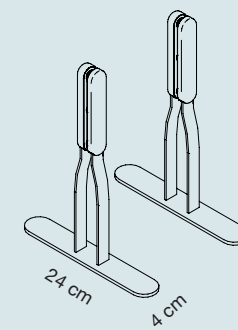

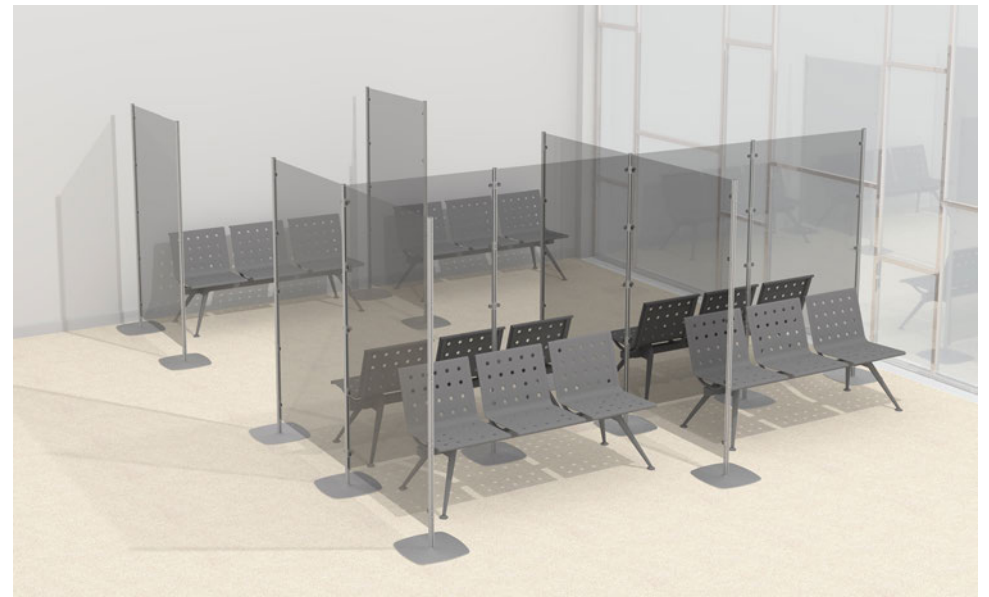
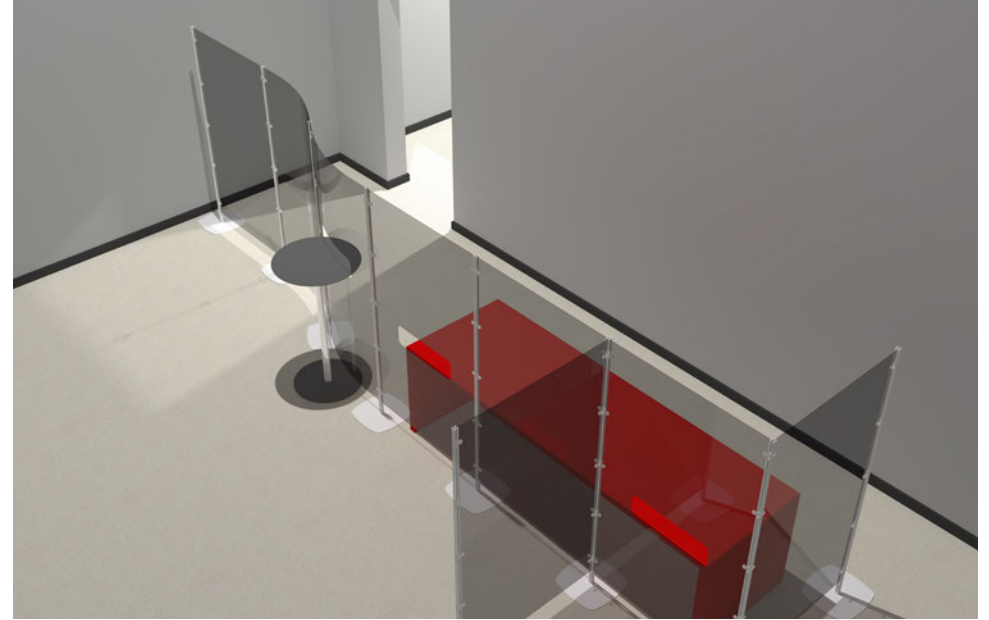

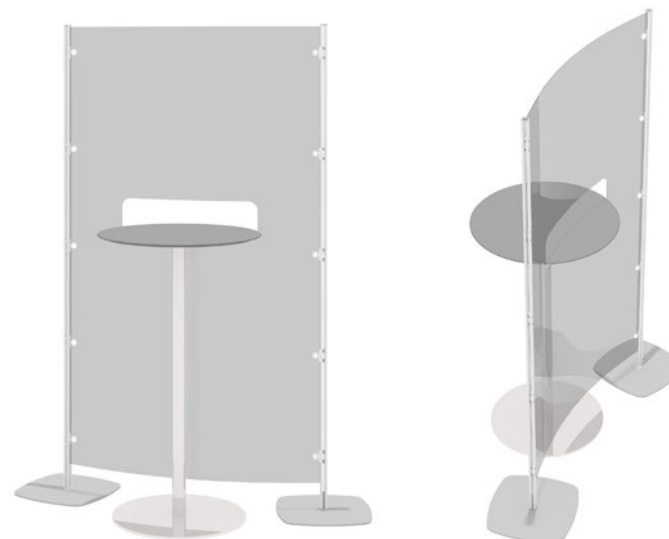
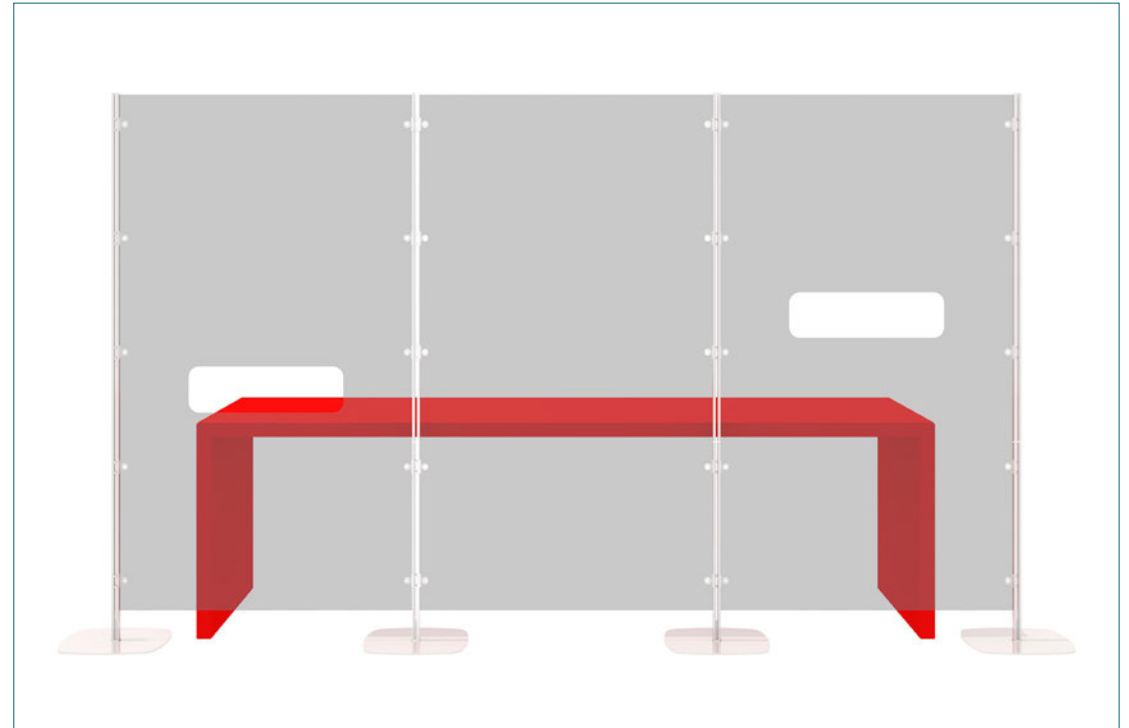
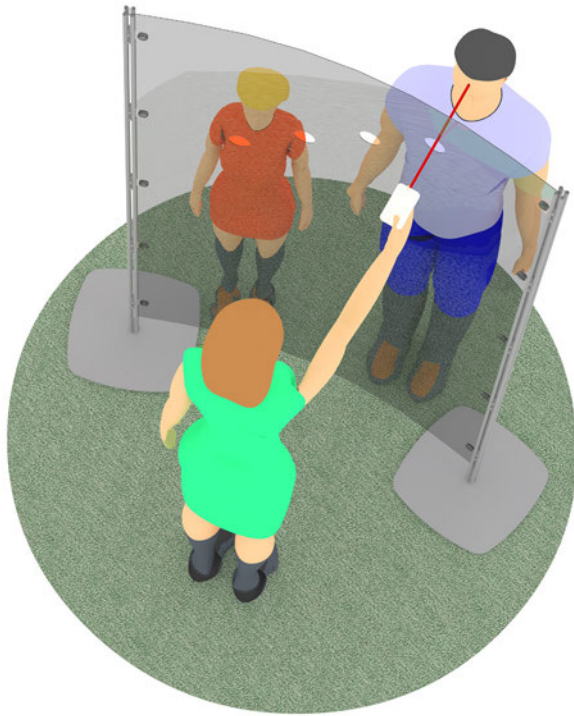

Gli schermi divisori in policarbonato trasparente sono forati per permettere il passaggio di fogli e oggetti.

Screen partitions made in transparent polycarbonate and perforated to allow the passage of paperwork and objects.

Les écrans de séparation en polycarbonate transparent sont percés pour permettre le passage de feuilles et objets.







Arianna è un sistema modulare di schermi divisori flessibili. I pannelli sono fissati ai montanti tramite attacchi fissi o particolari attacchi magnetici che consentono l'aggancio/sgancio rapido del pannello. I pannelli sono in policarbonato o PP mentre i montanti sono realizzati in acciaio verniciato con polveri epossidiche nei colori bianco opaco o grigio argento.

Arianna is a modular system with flexible partitions. Panels are attached to the uprights with either mechanical fixings or special magnetic fasteners that make the quick install/remove of the panels easy. Panels in polycarbonate or in PP. Uprights in matt white or silver grey powder-coated steel.

Arianna est un système modulaire de cloisons flexibles. Les panneaux sont fixés aux poteaux par des attaches fixes ou des attaches magnétiques particulières qui permettent de les accrocher/décrocher rapidement. Panneaux en polycarbonate ou PP. Poteaux en acier époxy, blanc mat ou gris argenté.



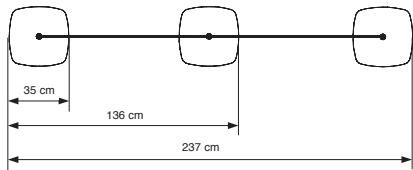
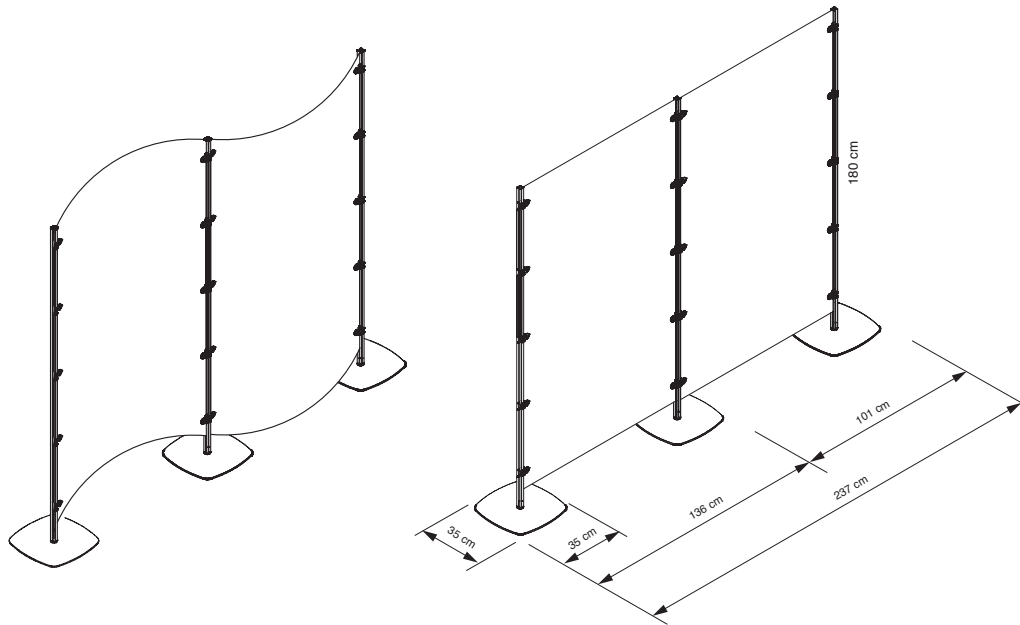

**PANELS FINISHES**

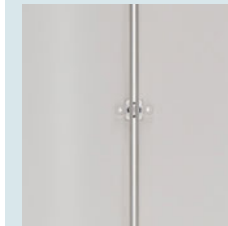

Policarbonato bisatinato o PP.  
Double satin polycarbonate or PP.  
Polycarbonate satiné double ou PP.

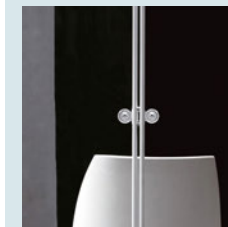

Policarbonato trasparente.  
Transparent polycarbonate.  
Polycarbonate transparent.



Policarbonato trasparente serigrafato.  
Screen-printed (transparent) finish polycarbonate.  
Polycarbonate transparent sérigraphié.

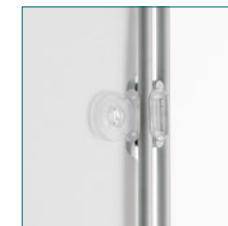

Attacchi fissi.  
Fixed connectors.  
Attaches fixes.

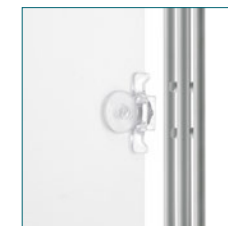

Attacchi magnetici.  
Magnetic connectors.  
Attaches magnétiques.





Arianna desk è un sistema modulare di schermi divisori flessibili. I pannelli sono fissati ai montanti tramite attacchi fissi o particolari attacchi magnetici che consentono l'aggancio/sgancio rapido del pannello. I pannelli sono in tecnopolimero trasparente mentre i montanti sono realizzati in acciaio verniciato con polveri epossidiche bianco opaco.

Arianna desk is a modular system with flexible partitions. Panels are attached to the uprights with either mechanical fixings or special magnetic fasteners that make easy the quick install/remove of the panels. Panels in transparent high-tech polymer. Uprights in matt white powder-coated steel.

Arianna desk est un système modulaire de cloisons flexibles. Les panneaux sont fixés aux poteaux par des attaches fixes ou des attaches magnétiques particulières qui permettent de les accrocher/décrocher rapidement. Panneaux en technopolymère transparent. Poteaux en acier époxy, blanc mat.

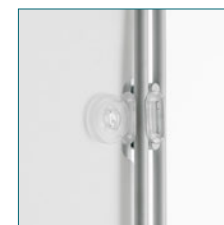

Attacchi fissi.

Fixed connectors.

Attaches fixes.

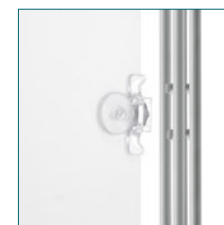

Attacchi magnetici.

Magnetic connectors.

Attaches magnétiques.





Sistema di schermi divisori componibili ed accessoriabili, costituito da elementi modulari che si assemblano in modo flessibile tra loro. Struttura in acciaio verniciato con polveri epossidiche nei colori bianco opaco o grigio argento. Pannelli in policarbonato trasparente o acciaio bugnato verniciato con polveri epossidiche nei colori bianco opaco o grigio argento.

System of modular and accessorized dividing screens, made up of flexible elements. Epoxy powder-coated steel structure in matt white or silver grey. Panels in transparent polycarbonate or textured epoxy powder-coated steel in matt white or silver gray.

Système de cloisons modulaires qu'on peut équiper avec accessoires, formé d'éléments modulaires assemblés de manière flexible. Structure en acier peint en époxy blanc mat ou gris argenté. Panneaux en technopolymère transparent ou en acier avec bossage peint en époxy blanc mat ou gris argenté.

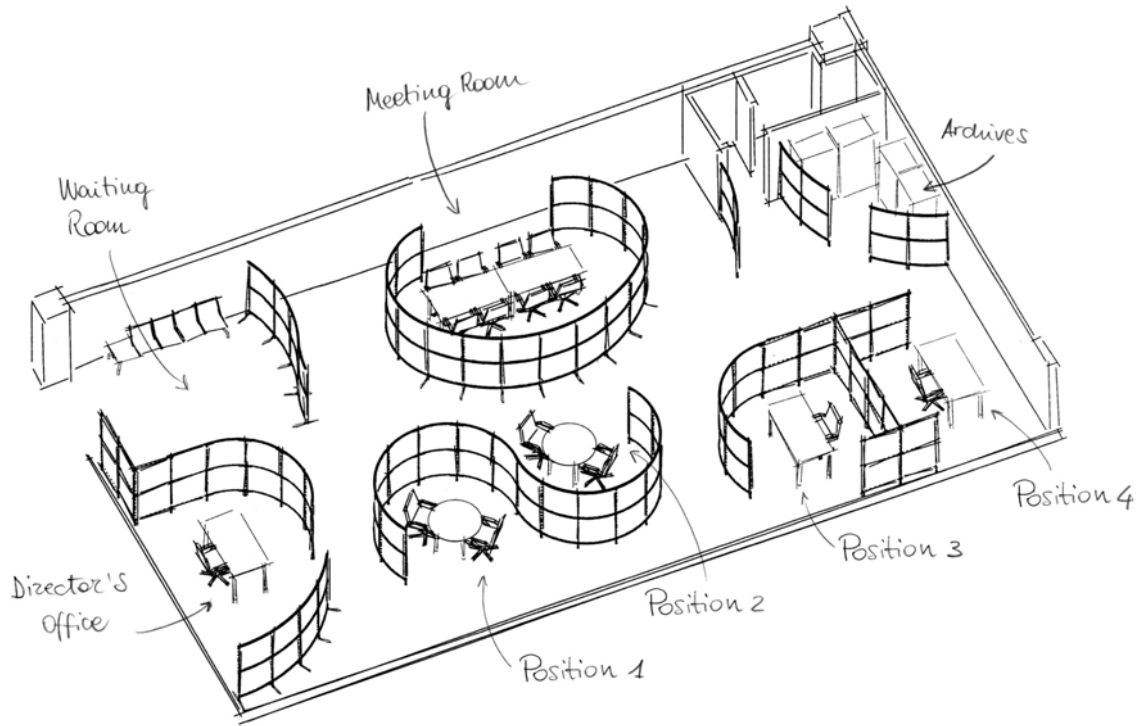

**PANELS FINISHES**

Acciaio bugnato.  
Bossage-finish steel.  
Acier avec bossage.

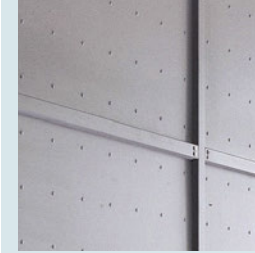

Policarbonato trasparente.  
Transparent high-tech polymer.  
Technopolymère transparent.

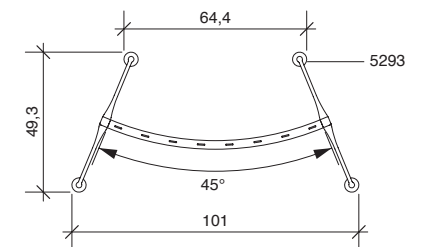
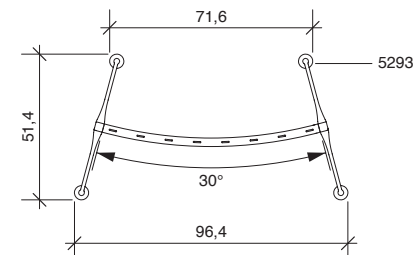
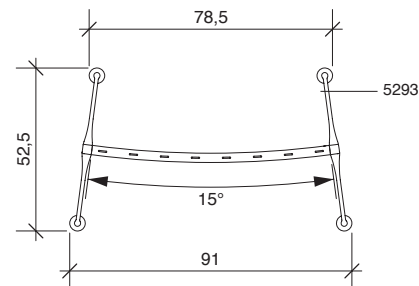
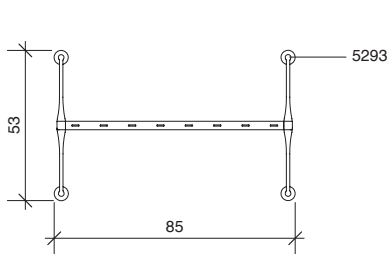
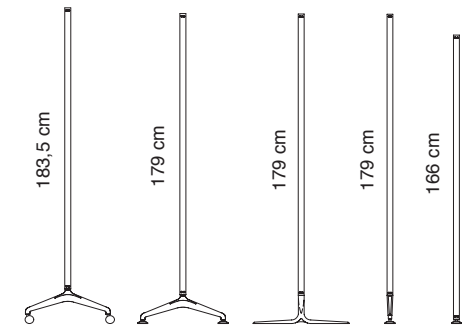

DIVISORI CON TESSUTO FONOASSORBENTE FIBER 1 BATTERIOSTATICO.  
DIVIDERS WITH SOUND ABSORBING FIBER 1 BACTERIOSTATIC FABRIC.  
CLOISONS AVEC TISSUS PHONO-ABSORBANTS FIBER 1 BACTERIOSTATIQUE.





Sistema di elementi divisori Battista semplice, elegante e flessibile. Colonne realizzate in acciaio verniciato, basi in ghisa e particolari in acciaio cromato e alluminio lucidato. Teli fonoassorbenti in poliestere Snowsound Fiber 1 batteriostatico Trevira bioactive. Il sistema è sfoderabile.

System of partitions Battista, simple, elegant and flexible. Columns in epoxy-powder coated steel, cast iron bases and parts in chrome-plated steel and polished aluminium. Sound absorbing fabric in Fiber 1 polyester bacteriostatic, Trevira bioactive. The fabric slipcover is removable.

Système de cloisons Battista, simple, élégant et flexible. Colonnes réalisées en acier peint, bases en fonte et détails en acier chromé et aluminium poli. Tissus phono-absorbants en polyester Snowsound Fiber 1 bacteriostatique Trevira bioactive. Le tissu est amovible.

FIBER 1 FINISHES

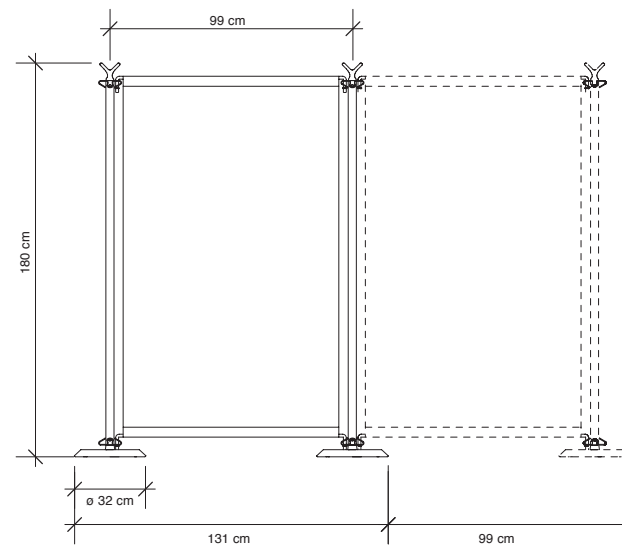



DIVISORI CON TESSUTO FONOASSORBENTE FIBER 1 BATTERIOSTATICO.  
 DIVIDERS WITH SOUND ABSORBING FIBER 1 BACTERIOSTATIC FABRIC.  
 CLOISONS AVEC TISSUS PHONO-ABSORBANTS FIBER 1 BACTERIOSTATIQUE.

Divisori fonoassorbenti realizzati con tessuto Snowsound Fiber 1 batteriostatico Trevira bioactive e strutture in tubolare di acciaio cromato montate su una sola base in tubolare che permette di accostare più divisori in linea o ad angolo. La base in tubolare è dotata di ruote poste alle estremità che ne consentono il facile spostamento. Il sistema è sfoderabile.

Sound absorbing dividers made with Snowsound Fiber 1 fabrics bacteriostatic Trevira bioactive and chromed-plated tubular steel structures mounted on a single tubular base that allows you to juxtapose several dividers in line or creating a corner. The tubular base is equipped with wheels located at the ends that allow easy movement. The fabric slipcover is removable.

Cloisons phono-absorbants réalisées en tissu Snowsound Fiber 1 bacteriostatique Trevira bioactive et structures en tube d'acier chromé montées sur une base unique plate en tubes que permet de disposer plusieurs cloisons en ligne droite ou en angle. La base en tube est munie de roulettes aux extrémités qui permettent un déplacement facile. Le tissu est amovible.







Sistema di sedute modulari con scocche e tavolini realizzati in lamiera di acciaio forata verniciata con polveri epossidiche oppure in acciaio inossidabile AISI 304 con finitura satinata. I supporti, le travi e le particolari basi coniche sono in acciaio verniciato con polveri epossidiche. Bracciolo in alluminio verniciato con polveri epossidiche.

Modular beam seating system with seats and side tables in epoxy powder-coated perforated steel sheet or in AISI 304 stainless steel sheet with satin finish. The supports, the beams and the conical bases are made from epoxy powder-coated steel. Powder-coated aluminium armrest.

Système modulaire de sièges sur poutre avec coque et tables réalisées en tôle d'acier perforée peint en epoxy ou en acier inoxydable AISI 304 avec finition satinée. Les supports, les poutres et les bases coniques très particulières sont en acier peint époxy. Accoudoirs en aluminium peint en époxy.



Ihr Fachhändler in Berlin:

**bam** büromöbel Handels GmbH

Richard-Wagner-Str. 48 | 10585 Berlin

Tel: +49 (30) 321 12 28 | [service@bam-bueromoebel.de](mailto:service@bam-bueromoebel.de)

[www.bam-bueromoebel.de](http://www.bam-bueromoebel.de)

**#CaimiSafeDesign**



**Caimi**  
BREVETTI

CAIMI BREVETTI S.p.A. - Via Brodolini, 25/27 - 20834 Nova Milanese - MB - Italy - Tel. 0362 49101  
Ufficio vendite Italia: Tel. 0362 491001 - Fax 0362 491060 - e-mail: [vendite.italia@caimi.com](mailto:vendite.italia@caimi.com)  
Export department: Tel. (+39) 0362 491002 - Fax (+39) 0362 491061 - e-mail: [export.dept@caimi.com](mailto:export.dept@caimi.com)  
[www.caimi.com](http://www.caimi.com)